

MAX kg



yakimaglobal.com

CONTENTS

5023359 x1
(M8)

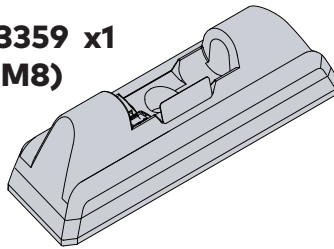

5023360 x1

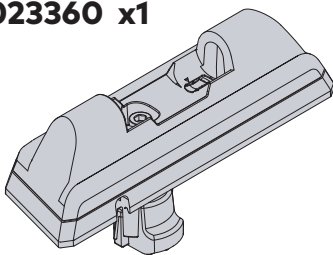

CATCH MOUNT(with screw)

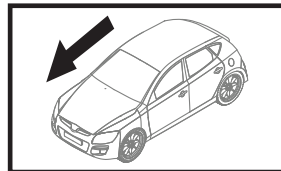

5023362 x1

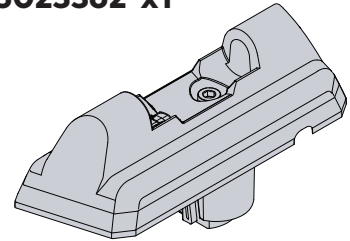

CATCH MOUNT(with screw)

5023361 x1
(M6)

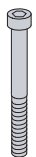
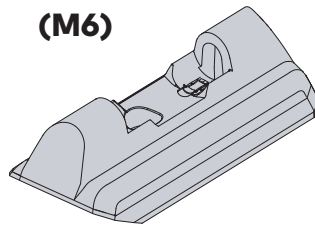

M6 x1



M6 x1



x1

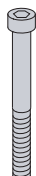

M8 x1



M8 x1

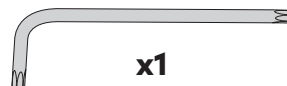

x1

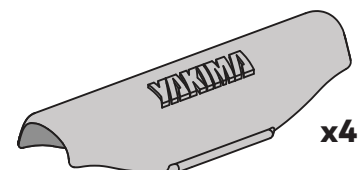

x4

1 REMOVE FACTORY CROSSBARS

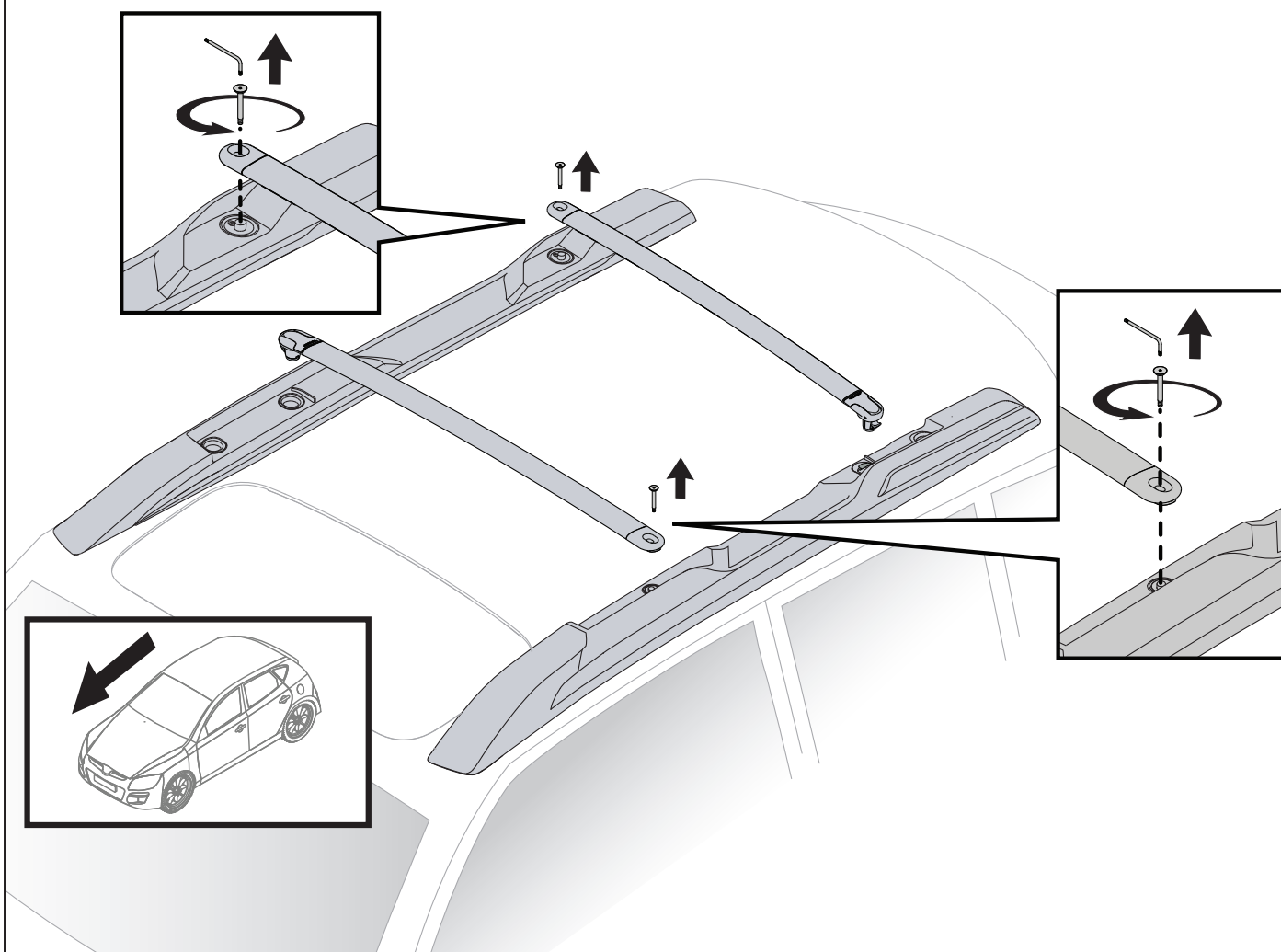

Front Right & Rear Left: Lift the tab to release the crossbar. Reference your owner's manual for more information.

Front Left & Rear Right: Use the supplied Torx key to remove the factory bolt securing the crossbar. Using the Torx key that came with your vehicle, remove the larger Torx bolt on the rear passenger corner. See owners manual for more information.



DO NOT DRIVE YOUR VEHICLE WITHOUT EITHER FACTORY CROSSBARS OR YAKIMA LANDING PADS INSTALLED.

2

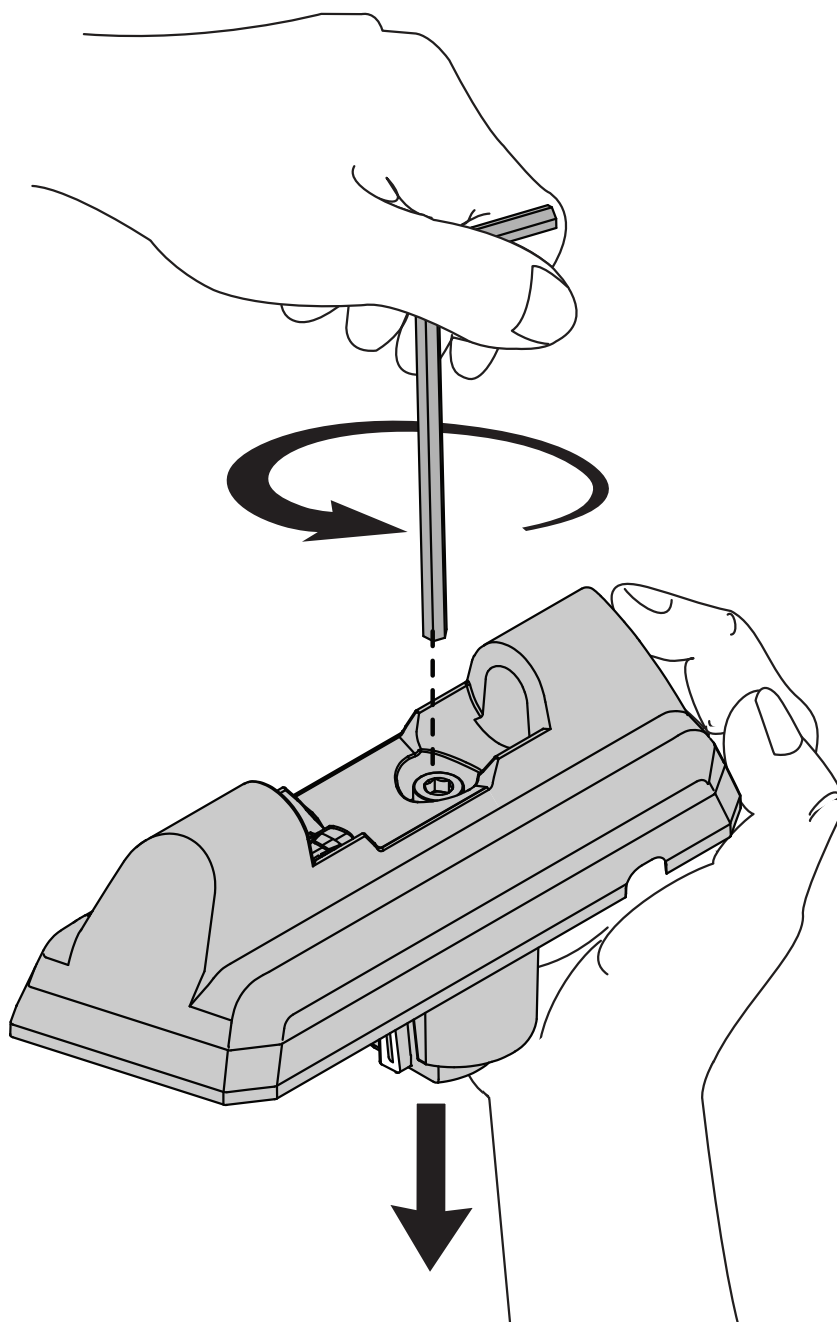

Using the hex key fully open both Catch Mounts (5023360 and 5023362) by turning the screw counter-clockwise.

NOTE: Use caution to not dislodge the circlip on the bottom of the bolt.

x2

3

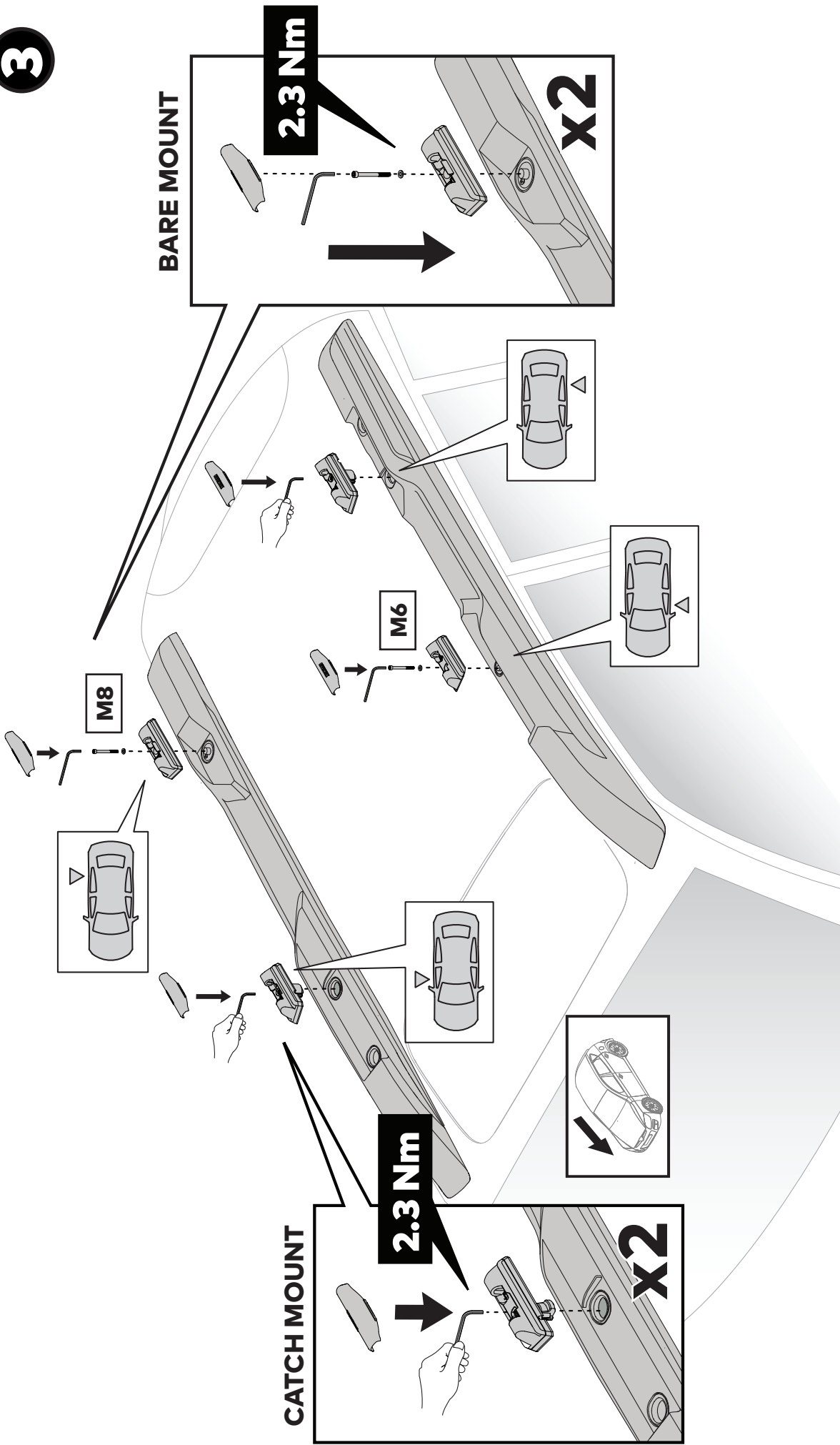

To prevent the screws from cross-threading start threading the fastener using your fingers. Tighten to final torque (2.3 Nm).

4

Continue with your SkyLine or SkyLine FX installation according to the instruction.

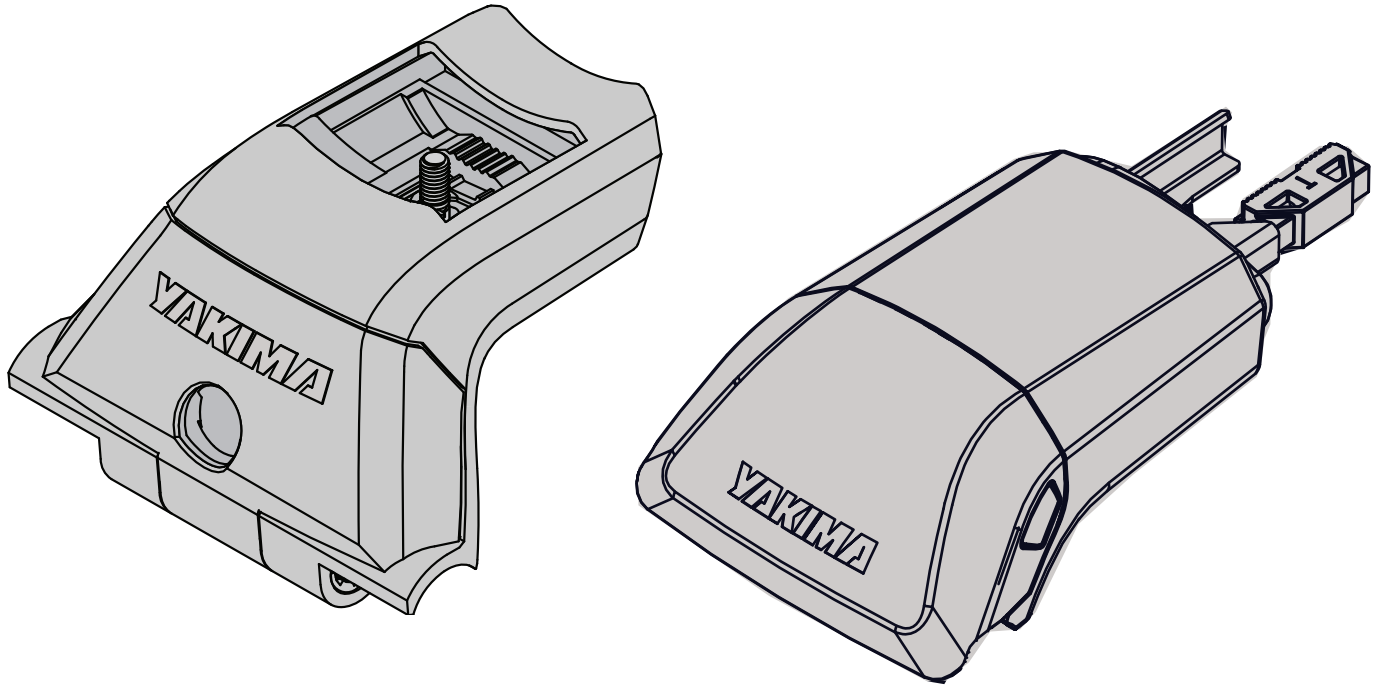

EN ACCESSING INSTRUCTIONS, LOAD RATING, SAFETY AND WARRANTY INFO

- DE** Zugriff auf Anweisungen, Tragfähigkeit, Sicherheits- und Garantieinformationen
- ES** Acceso a las instrucciones, capacidad de carga, seguridad e información de garantía
- FR** Accès aux instructions, à la capacité de charge, aux informations sur la sécurité et la garantie
- NO** Tilgang til veiledninger, bæreevne, sikkerhet og garantiinformasjon
- PT** Aceder a informações relativas a instruções, capacidade de carga, segurança e garantia
- IT** Accesso istruzioni, classe di carico, informazioni su sicurezza e garanzia
- PL** Dostęp do instrukcji, wartości ładowności, informacji dot. BHP i gwarancji
- CS** Přístup k návodům, údajům o nosnosti, bezpečnostním a záručním informacím
- SK** Prístup k návodom, nosnosti a informáciám o bezpečnosti a záruke
- NL** Toegangs instructies, draagvermogen, veiligheids- en garantie-informatie
- SV** Tillgång till instruktioner, belastningsklass, säkerhets- och garantiinformation
- DK** Adgang til instruktioner, belastningsklasse, sikkerhed og garantioplysninger
- UA** Доступ до інструкцій, інформації про допустимі навантаження, безпеку та гарантії
- FI** Pääsy ohjeisiin, kuormitusarvoihin, turvallisuus- ja takuutietoihin

1. EN SCAN QR CODE

- | | |
|------------------------------------|------------------------------|
| DE Scannen Sie den QR-Code | CS Naskenujte QR kód |
| ES Escanea el código QR | SK Naskenujte QR kód |
| FR Scanner le code QR | NL Scan QR-code |
| NO Skann QR-kode | SV Skanna QR-koden |
| PT Leia o código QR | DK Scan QR code |
| IT Scannerizza il codice QR | UA Відскануйте QR-код |
| PL Zeskanuj kod QR | FI Skanna QR-koodi |

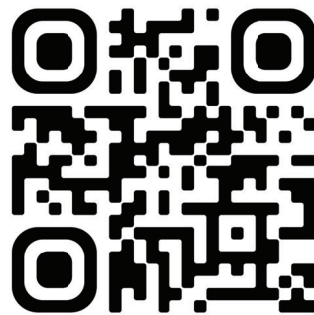

yakimaglobal.com



2. EN SELECT YOUR LOCATION

- | | | |
|--|-------------------------------------|---|
| DE Wählen Sie Ihren Standort | IT Scegli la località | SV Välj din plats |
| ES Selecciona tu ubicación | PL Wybierz swoją lokalizację | DK Vælg din placering |
| FR Sélectionner votre emplacement | CS Vyberte si polohu | UA Оберіть ваше місце розташування |
| NO Velg din plassering | SK Vyberte svoju lokalitu | FI Valitse sijaintisi |
| PT Selecione a sua localização | NL Selecteer je locatie | |

3. EN LOOK UP YOUR VEHICLE OR PRODUCT, LOAD RATING, SAFETY AND WARRANTY INFO

- DE** Suchen Sie Ihr Fahrzeug oder Produkt, Tragfähigkeit, Sicherheit und Garantieinformationen
- ES** Busca tu vehículo o producto, la capacidad de carga, la seguridad y la información de garantía
- FR** Rechercher votre véhicule ou votre produit, la capacité de charge, la sécurité et les informations de garantie
- NO** Slå opp kjøretøyet eller produktet ditt, bæreevne, sikkerhet og garantiinformasjon
- PT** Procure informações relativas a instruções, capacidade de carga, segurança e garantia do seu veículo ou produto
- IT** Cerca il tuo veicolo o il prodotto, la classe di carico, le informazioni su sicurezza e garanzia
- PL** Wyszukaj pojazd lub produkt, udźwig, informacje dot. BHP i gwarancji
- CS** Vyhledejte své vozidlo nebo výrobek, údaje o nosnosti a informace o bezpečnosti a záruce
- SK** Vyhľadajte svoje vozidlo alebo produkt, nosnosť a informácie o bezpečnosti a záruke
- NL** Zoek je voertuig of product, draagvermogen, veiligheids- en garantie-informatie
- SV** Slå upp ditt fordon eller produkt, belastningsklass, säkerhets- och garantiinformation
- DK** Slå dit køretøj eller produkt op, samt belastningsklasse, sikkerheds- og garantioplysninger
- UA** Знайдіть інформацію про ваш автомобіль або виріб, допустимі навантаження, безпеку та гарантії
- FI** Katso ajoneuvosi tai tuotteesi, kuormitusluokitus, turvallisuus- ja takuutiedot

This page intentionally left blank



www.yakima.com.au
www.yakima.co.nz
www.yakima.com
www.yakima.eu

YAKIMA AUSTRALIA PTY LTD

17 Hinkler Court
Brendale, QLD 4500
Australia
1800 143 548
yakimaglobal.com

YAKIMA PRODUCTS, INC.

4101 Kruse Way
Lake Oswego, OR
97035-2541
USA
888 925 4621
yakima.com/support