

**EN** Fitting Instructions for Basic Carrier

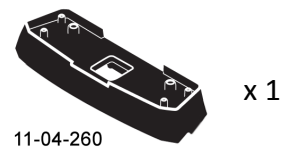

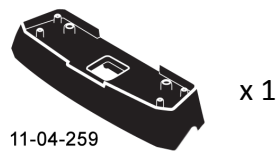

x 2

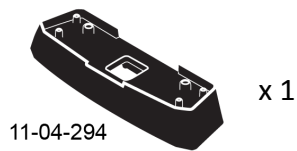
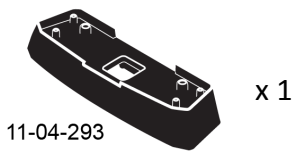
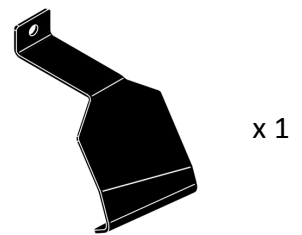
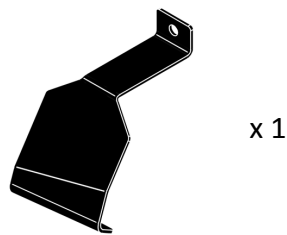
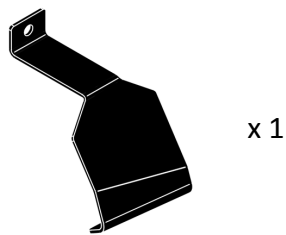
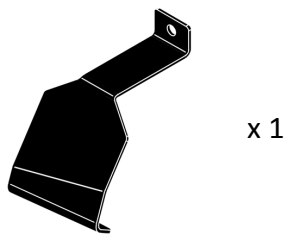
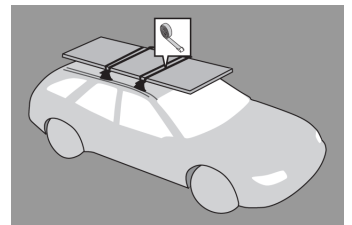
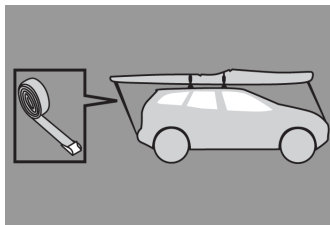
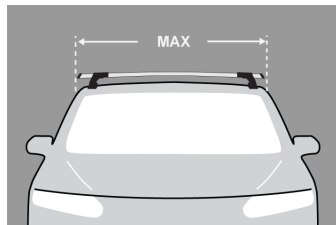
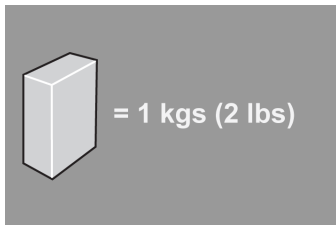

x 2

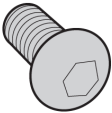

x 4



x 4



x 1

3 mm



## MAX kgs (lbs)

🚩 W/P WHD

### Nissan

Qashqai, 5dr SUV 14-+

ZA 60 kgs (132 lbs) 60 kgs (132 lbs)

Qashqai, 5dr SUV 16-16

CN 60 kgs (132 lbs) 60 kgs (132 lbs)

Qashqai, 5dr SUV Feb 14-+

EU 60 kgs (132 lbs) 60 kgs (132 lbs)

Qashqai, 5dr SUV Jun 14-+

NZ 60 kgs (132 lbs) 60 kgs (132 lbs)

Qashqai, 5dr SUV Jun 14-+

AU 60 kgs (132 lbs) 60 kgs (132 lbs)

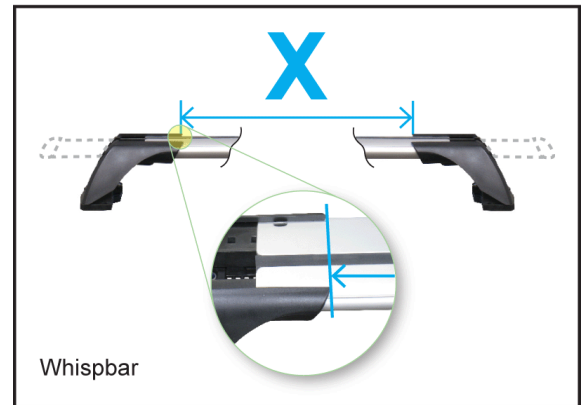
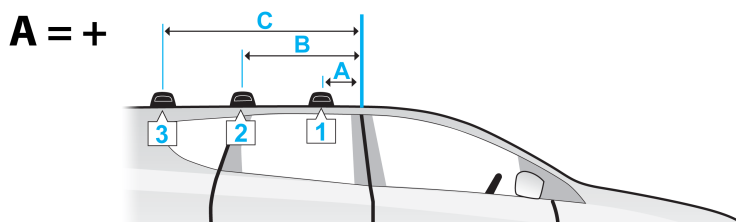
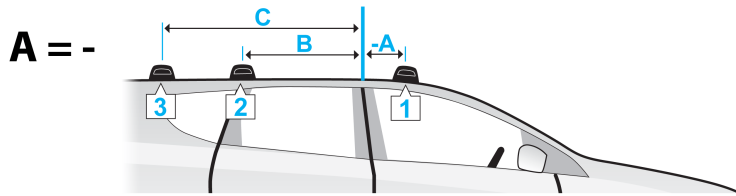

Qashqai, 5dr SUV 14-+ (ZA)

	A	B	C	X		
				1	2	3
Qashqai, 5dr SUV 14-+ (ZA)	-380mm	370mm	-	952mm	897mm	-
	-14 -15/16ths"	14 9/16ths"	-	37 1/2ths"	35 5/16ths"	-

Qashqai, 5dr SUV 16-16 (CN)

Qashqai, 5dr SUV 16-16 (CN)	-380mm	370mm	-	952mm	897mm	-
	-14 -15/16ths"	14 9/16ths"	-	37 1/2ths"	35 5/16ths"	-

Qashqai, 5dr SUV Feb 14-+ (EU)

Qashqai, 5dr SUV Feb 14-+ (EU)	-380mm	370mm	-	952mm	897mm	-
	-14 -15/16ths"	14 9/16ths"	-	37 1/2ths"	35 5/16ths"	-

Qashqai, 5dr SUV Jun 14-+ (NZ)

Qashqai, 5dr SUV Jun 14-+ (NZ)	-380mm	370mm	-	952mm	897mm	-
	-14 -15/16ths"	14 9/16ths"	-	37 1/2ths"	35 5/16ths"	-

Qashqai, 5dr SUV Jun 14-+ (AU)

Qashqai, 5dr SUV Jun 14-+ (AU)	-380mm	370mm	-	952mm	897mm	-
	-14 -15/16ths"	14 9/16ths"	-	37 1/2ths"	35 5/16ths"	-

## First Time Installation



- Remove parts from inside the package and check. Contact your dealer if any parts are missing or damaged.

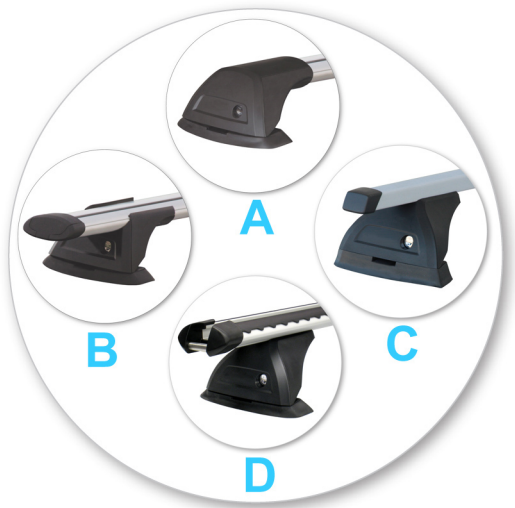

- This kit fits type A, B, C and D.
- These instructions show type A crossbar fitted. They also apply to type B, C and D.

**NOTE: Clamp images in these instructions may not be representative of the clamps in this kit**

- Use keys to remove covers.



- Use hex screwdriver to reverse adjusting screw 10 turns.



- Press adjusting screw and pull crossbar legs out. Refer to the crossbar instructions for crossbar adjustment method.
- Ensure each end of the crossbar is adjusted equally.





- Remove locking screw.

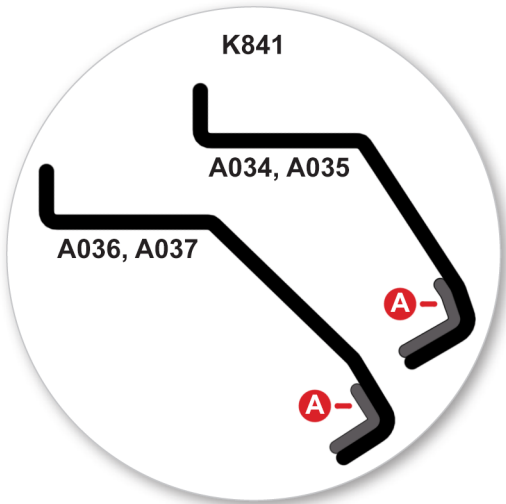

- Apply protective strip as shown. Trim if required.
- A = Grey

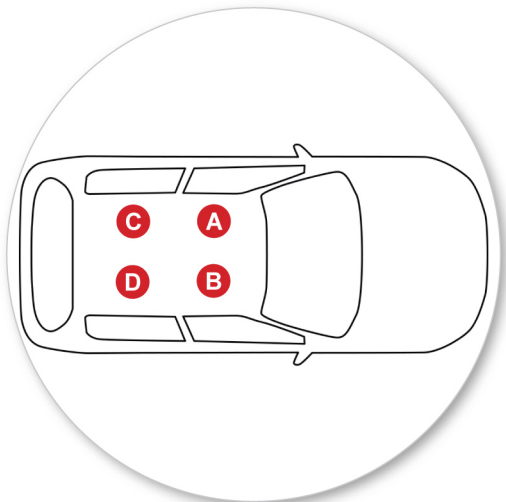

- It is important to put the clamps in the correct position on the vehicle.
- Letters refer to the part numbers stamped on clamps.
- Clamp Part Number:  
A = A034  
B = A035  
C = A036  
D = A037



- Attach clamp to each leg. NOTE; clamps may have labels showing their positions on the vehicle (For example; "Front Right").



- Refit locking screw so that it goes through the hole in the clamp. Do not begin to tighten the locking screw.



- Refer to the underside of the pad for the part number.



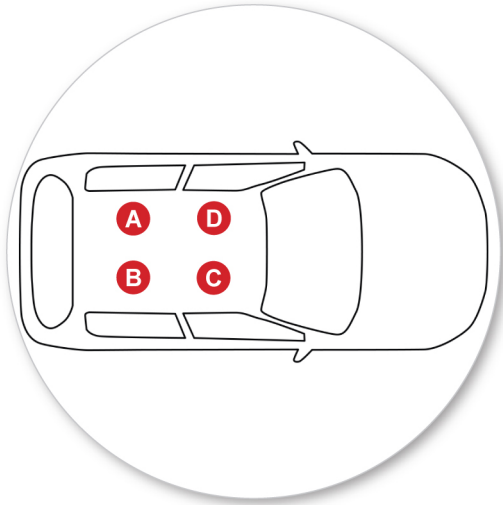

- It is important to put the pads in the correct position on the vehicle.
- Letters refer to the pad part numbers and position.
- Pad Part Number:  
A = 259A  
B = 260A  
C = 293A  
D = 294A



- Place rubber pads (supplied with fitting kit) on the vehicle roof. Pad may vary in shape to that shown.



- Make sure the pad fits into the holes underneath the foot.

## Fitment



- Clamps directly to edge of roof under the doors
- Please check the front of this manual for information relating specifically to your vehicle.
- Place crossbar on vehicle. Minimum recommended spacing between the bars is 700mm (27 1/2") (unless otherwise stated).



- Adjust the legs on the crossbar so that they are positioned equally from the ends of the crossbar, and the clamps engage firmly on the body work of the vehicle.



- Place washer onto the capscrew.
- Place clamp over the mounting hole
- Attach capscrew with the Hex Key. Do not fully tighten.
- Leave loose until both sides have had the screw fitted.



- Tighten adjusting screw to 3 Nm (2.2 ft lb) hand tight.



- Tighten locking screw on both legs evenly, 3 Nm (2.2 ft lb).



- Use hex key to tighten locking capscrew.
- Do not over tighten.
- Please take care when closing the doors as contact can be made with the clamp if it is not installed correctly. Close the door slowly upon first inspection.

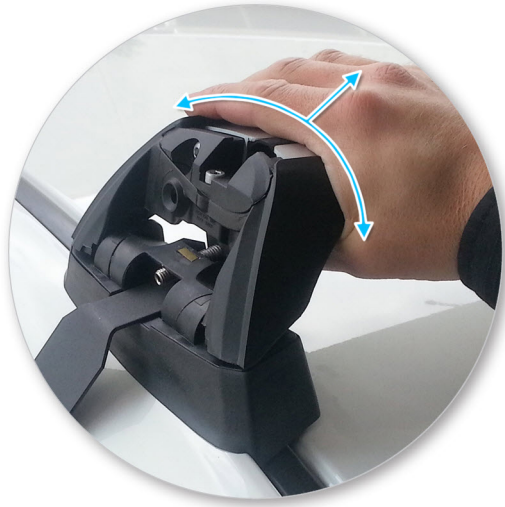

- Check crossbar is securely attached to the vehicle.



- Use keys to fit and lock covers

**CAUTION: Recheck all fasteners immediately after a load is applied to the crossbars. Regularly check screws are tight.**

## Maintenance

- Clean the car roof and surfaces of the product that will be in contact with the car roof.
- Follow the fitting instructions for fitting the product to your vehicle. Make sure all steps are carried out in order.
- Set crossbars a minimum distance of 700mm (27 1/2") apart where no other distance is specified in the fitting instructions. This is especially important when carrying long loads.
- Check unit is securely attached whenever you refit it to the vehicle. If the unit feels loose, refer to the fitting instructions and readjust.
- Some glass/panoramic roofs and radio antennae may not be able to be used when the product is fitted.
- Do not modify this product.
- Refer to the maximum permitted load capacity specified in the fitting instructions. Do not exceed the vehicle manufacturers roof load rating if it is lower than the maximum load capacity specified in the fitting instructions.
- Loads should not overhang the sides of the product and be evenly distributed with the lowest possible centre of gravity.
- Long loads should be secured with non-elastic straps to the front and rear of the vehicle.
- Objects with pointed ends (e.g. ski poles) should be carried with the pointed ends to the rear of the vehicle.
- Remove all loose or removable objects from the load prior to loading.
- Make sure all loads are securely fastened with non-elastic straps. Check regularly during longer journeys.
- A loaded roof rack system can alter the performance of your vehicle. Be especially aware of the effects of side winds, changing of direction, and braking performance. Avoid rapid acceleration and deceleration. Drive carefully.
- Note that the total height of the vehicle increases when upright loads are carried.
- Products should be locked during transport if they have locks fitted.

- Check and replace worn out or defective parts.
  - Keep the product clean and maintained.
  - Never drive into a car wash with the roof rack system fitted.
  - Lubricate locks and adjusting screws at regular intervals.
  - Remove the products from the vehicle when not in use. Make sure all loose parts are stored safely.
- 

- Yakima Europe Coöperatief U.A.  
Archimedesbaan 25  
3439 ME Nieuwegein  
The Netherlands

+31 2080 81425

[www.whispbar.eu](http://www.whispbar.eu)  
[www.whispbar.co.uk](http://www.whispbar.co.uk)

---

- Yakima Products, Inc.  
4101 Kruse Way,  
Lake Oswego, OR 97035  
USA

[www.whispbar.com](http://www.whispbar.com)  
[www.whispbar.ca](http://www.whispbar.ca)

---