

DK522 CROSSBAR INSTRUCTION

VA, EURO & HD

FIT MY VEHICLE

Please visit the Rhino-Rack website to ensure you have the latest information for your specific vehicle.



rhinorack.com/roof



CROSSBAR ID

PAD, CLAMP & CROSSBAR DETAILS

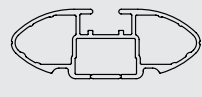

VA



EURO



HD

FRONT CROSSBAR

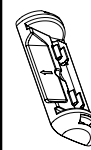
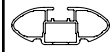
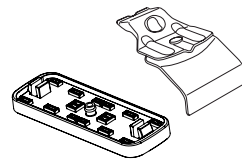

REAR CROSSBAR

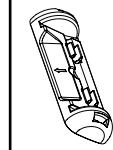
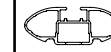
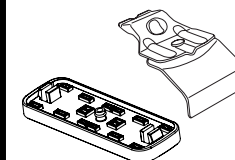

| Vehicle | Date | Crossbar | FRONT CROSSBAR | | | | | REAR CROSSBAR | | | | | | |
|-------------------------|--------|----------|-------------------------|------------------------|-----------------------------------|-------|--------------------------|----------------------------|----------------------|---------------------|-----------------------------------|-------|--------------------------|----------------------------|
| | | | Front Right Pad / Clamp | Front Left Pad / Clamp | Measurement Strip Length Per Side | | Measurement Distance (X) | Foot Plate Arrow Direction | Rear Right Pad/Clamp | Rear Left Pad/Clamp | Measurement Strip Length Per Side | | Measurement Distance (X) | Foot Plate Arrow Direction |
| Honda HR-V Gen3 5dr SUV | 2021 - | 1180mm | M506 / SUB0460 | M505 / SUB0460 | 231mm | 176mm | 1030mm / 9 1/8" | OUT | M506 / SUB0373 | M505 / SUB0373 | 193mm | 138mm | 954mm / 37 9/16" | OUT |
| | | | Pad Arrow Forward | | | | | | Pad Arrow Forward | | | | | |

DK522 CROSSBAR INSTRUCTION

VA, EURO & HD

Carrying Capacity: The roof rack is rated to 75kg. Please refer to manufacturers handbook for your vehicles maximum roof load capacity. Always use the lower of the two figures.

- (A)** CENTRE of Door Jamb to CENTRE of Front Leg Foot Plate Arrow.
- (B)** CENTRE of Front leg foot plate arrow to CENTRE of Rear leg foot plate arrow.
- (C)** Door Jamb to CENTRE of Rear Leg Foot Plate Arrow

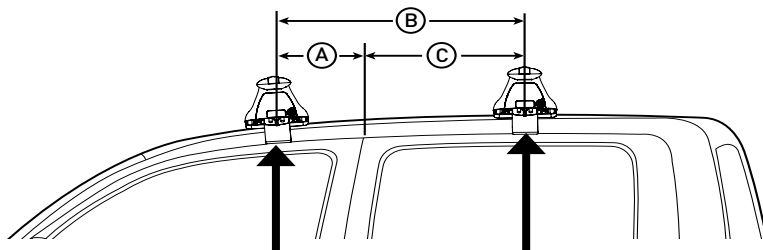

Honda has indented arrows in the door jambs (visible when doors are opened) to indicate placement of roof racks. Place Front and Rear crossbars above the indicators and cross-check by using the table below

Direction of Pad and Foot Plate Arrow

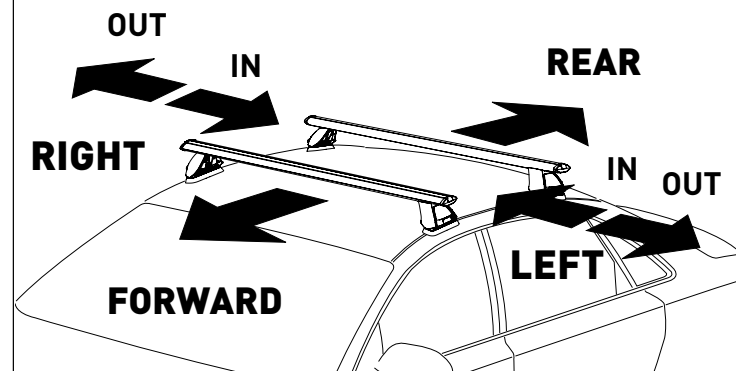

| VEHICLE | Date | (A) | (B) | (C) | Load Rating (includes racks 5kg/ 11lbs) |
|-------------------------|--------|-------|-------|-------|--|
| Honda HR-V Gen3 5dr SUV | 2021 - | 245mm | 600mm | 355mm | Up to* 75kg / 165lbs |

*System Load Rating: Please refer to manufacturer's handbook for your vehicle's maximum roof load capacity. Always use the lower of the two figures