

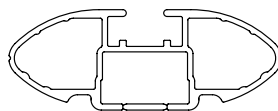

IDENTIFICATION CHART

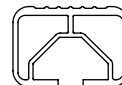

VA crossbar



ALLOY Crossbar

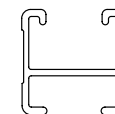

HD crossbar

Check Rhino Rack website to ensure these are the latest issue of instructions to suit the fit for the vehicle.

Vehicle	Date	Crossbar	FRONT CROSSBAR					REAR CROSSBAR						
			Front Right Pad/ Clamp	Front Left Pad/ Clamp	Measurement strip length per side	Measurement strip length per side	Measurement Distance (x)	Foot plate arrow direction	Rear Right Pad/ Clamp	Rear Left Pad/ Clamp	Measurement strip length per side	Measurement strip length per side	Measurement Distance (x)	Foot plate arrow direction
Ford Ranger PX Double Cab	2011-	1260mm	M367 SUB0146		191mm	78mm	1040mm / 40,15/16"	OUT	M367 SUB0145		180mm	67mm	1020mm/ 40,3/16"	OUT
			Arrow FORWARD						Arrow FORWARD					
Ford Ranger PX Double Cab (single FRONT bar)	2011-	1260mm	M367 SUB0146		191mm	78mm	1040mm/ 40,15/16"	OUT	N/A	N/A	N/A	N/A	N/A	N/A
			Arrow FORWARD						N/A					
Ford Ranger PX Double Cab (single REAR bar)	2011-	1260mm	N/A		N/A	N/A	N/A	N/A	M367 SUB0145		180mm	67mm	1020mm/ 40,3/16"	OUT
			N/A						Arrow FORWARD					
Mazda BT50 Dual Cab	2011-	1260mm	M367 SUB0146		191mm	78mm	1040mm/ 40,15/16"	OUT	M367 SUB0145		180mm	67mm	1020mm/ 40,3/16"	OUT
			Arrow FORWARD						Arrow FORWARD					
Mazda BT50 Dual Cab (single FRONT bar)	2011-	1260mm	M367 SUB0146		191mm	78mm	1040mm/ 40,15/16"	OUT	N/A	N/A	N/A	N/A	N/A	N/A
			Arrow FORWARD						N/A					



IDENTIFICATION CHART

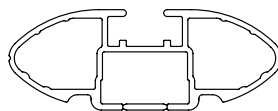

VA crossbar

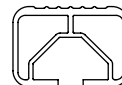

ALLOY Crossbar

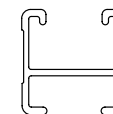

HD crossbar

Check Rhino Rack website to ensure these are the latest issue of instructions to suit the fit for the vehicle.

Vehicle	Date	Crossbar	FRONT CROSSBAR					REAR CROSSBAR						
			Front Right Pad/ Clamp	Front Left Pad/ Clamp	Measurement strip length per side	Measurement strip length per side	Measurement Distance (x)	Foot plate arrow direction	Rear Right Pad/ Clamp	Rear Left Pad/ Clamp	Measurement strip length per side	Measurement strip length per side	Measurement Distance (x)	Foot plate arrow direction
Mazda BT50 Dual Cab (single REAR bar)	2011-	1260mm			N/A	N/A	N/A	N/A			180mm	67mm	1020mm/ 40,3/16"	OUT



DK294 Rhino-Rack VA, Aero, Euro & HD crossbar instruction

CONTROLLED

Measurement A: CENTRE of door jamb to CENTRE arrow of leg foot plate.

Measurement B: CENTRE of Front leg foot plate arrow to CENTRE of Rear leg foot plate arrow.

Carrying capacity: Roof rack is rated to 75kg. Please refer to manufacturers handbook for your vehicles maximum roof load capacity. Always use the lower of the two figures.

If your vehicle is not listed on this fitting instruction please refer to your countries Rhino-Rack web site for the latest information.

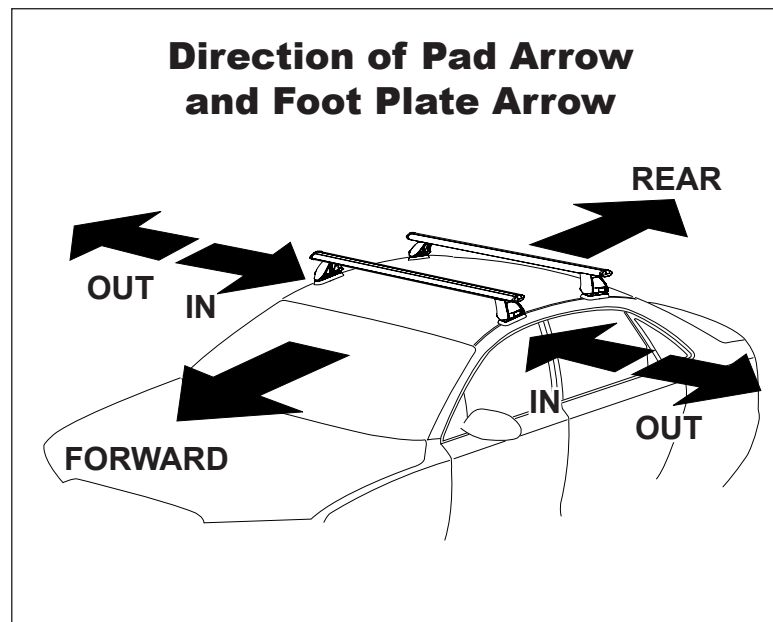
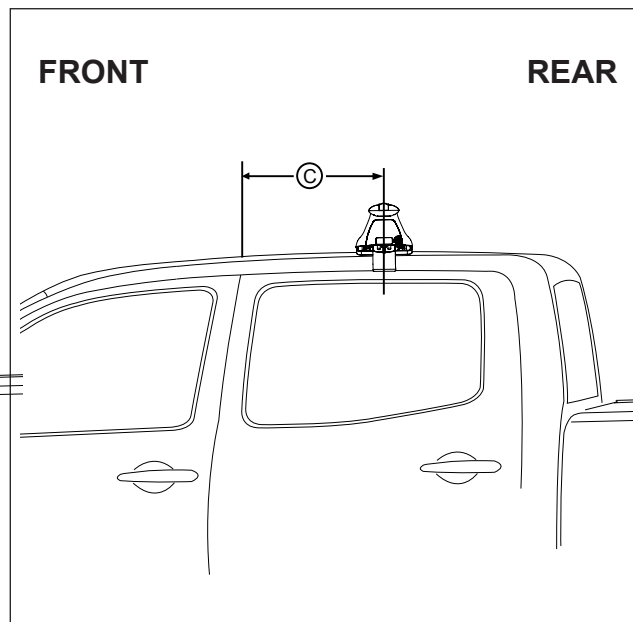
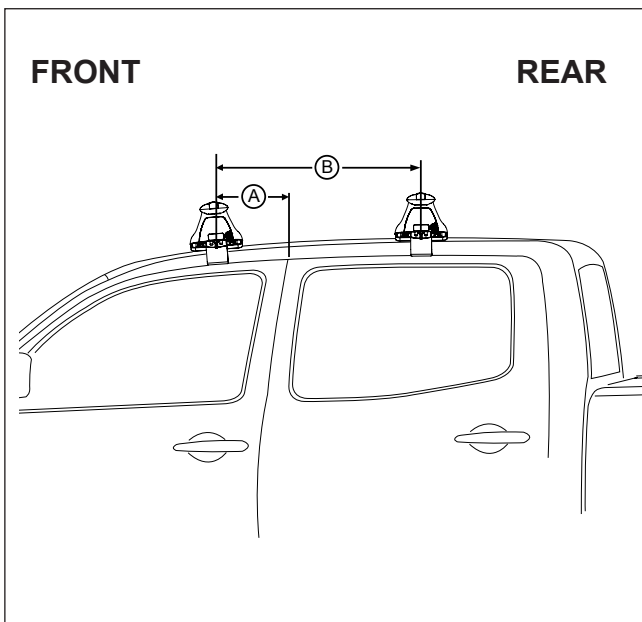

VEHICLE	Date	Measurement A	Measurement B	Measurement C	Load Rating (includes racks 5kg/ 11lbs)
Ford Ranger PX Double Cab	2011-	200mm / 7,7/8"	800mm / 31,1/2"	N/A	75kg / 165lbs
Ford Ranger PX Double Cab (single FRONT bar)	2011-	200mm / 7,7/8"	N/A	N/A	35kg / 77lbs
Ford Ranger PX Double Cab (single REAR bar)	2011-	N/A	N/A	600mm / 23,5/8"	35kg / 77lbs
Mazda BT50 Dual Cab	2011-	200mm / 7,7/8"	800mm / 31,1/2"	N/A	75kg / 165lbs
Mazda BT50 Dual Cab (single FRONT bar)	2011-	200mm / 7,7/8"	N/A	N/A	35kg / 77lbs
Mazda BT50 Dual Cab (single REAR bar)	2011-	N/A	N/A	600mm / 23,5/8"	35kg / 77lbs