



## Thule XT Kit 3157

# > Instructions

**SUBARU** Impreza (Mk. V), 5-dr Hatchback, 17-

This kit is only for vehicles with fixpoint mounting.

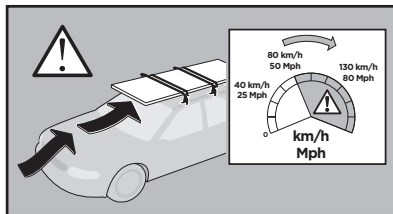
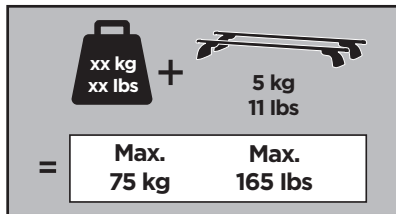
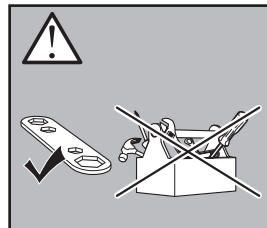
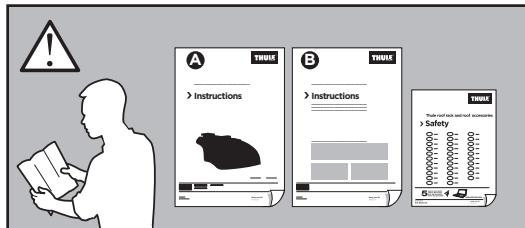

ISO 11154-E

183157

C.20161012  
509-3157-01

Bring your life  
thule.com

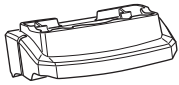

◀ 41 x1

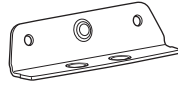

◀ 32 x4

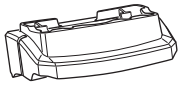

◀ 42 x1

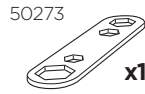

50273 x1

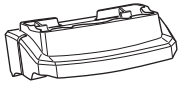

◀ 43 x1



50784 x8

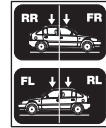

x1

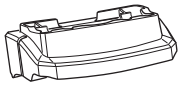

◀ 44 x1



50786 x8

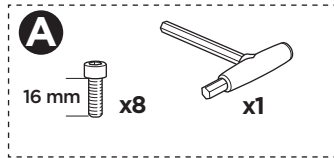

**A**  
16 mm x8

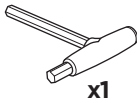

x1



52826 x8

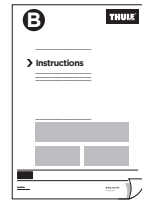

x1

**1**

**32**

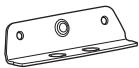

**41**



**42**



**32**

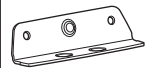

**32**

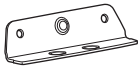

**43**

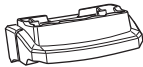

**44**

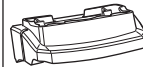

**32**

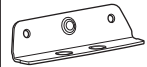

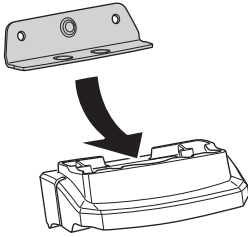
**2****B**

**A** 16 mm  x8

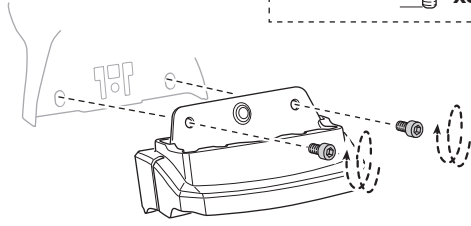

<b>EN</b> Only a few turns	<b>ET</b> Ainult mõni pööre	<b>RO</b> Doar câteva rotiri
<b>DE</b> Nur wenige Umdrehungen	<b>LV</b> Tikai dažī apgriezieni	<b>HU</b> Csak néhány fordítás
<b>FR</b> Quelques tours uniquement	<b>LT</b> Tik keli pasukimai	<b>EL</b> Μόνο λίγες περιστροφές
<b>NL</b> Slechts enkele slagen	<b>PL</b> Wystarczy kilka obrotów	<b>TR</b> Yalnızca birkaç tur
<b>IT</b> Solo qualche giro	<b>RU</b> Только несколько оборотов	<b>AR</b> بعض دورات فقط
<b>ES</b> Sólo algunas vueltas	<b>UK</b> Лише декілька обертів	<b>HE</b> רק מספר סיבובים
<b>PT</b> Apenas algumas voltas	<b>BG</b> Само няколко завъртания	<b>ZH</b> 仅几圈
<b>SV</b> Endast några varv	<b>CS</b> Pouze několik otáček	<b>JA</b> 2～3回転のみ
<b>DK</b> Kun nogle få omgange	<b>SK</b> Len niekoľko otáčok	<b>KO</b> 몇 번만 돌리면 됨
<b>NO</b> Bare noen få omdreininger	<b>SL</b> Le nekaj obratov	<b>TH</b> เพียงสองสามรอบ
<b>FI</b> Vain muutama kierros	<b>HR/BIH</b> Samo nekoliko okreta	

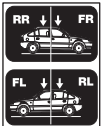
**3**

x1

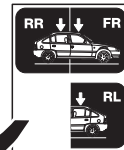
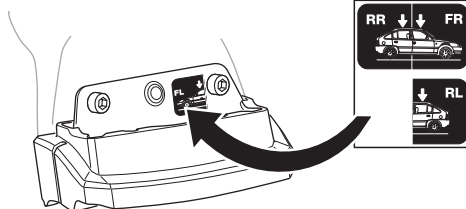

**4**

x8



x8



x8

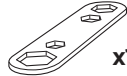

x1

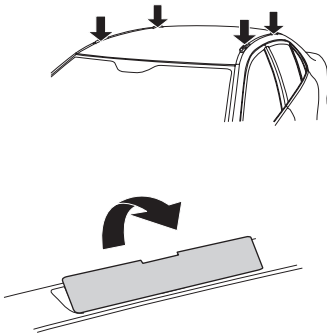
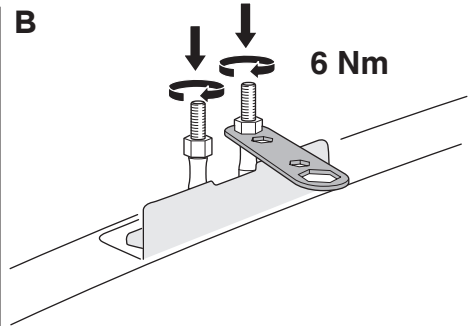
**A****B**

6 Nm

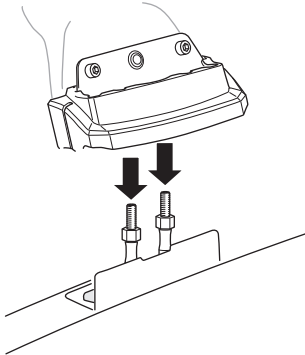
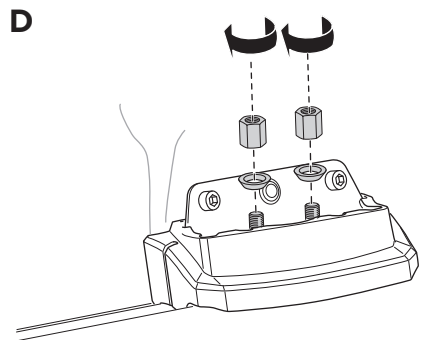
**C****D****5****A****A**

x1

6 Nm

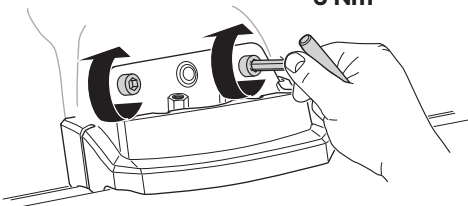
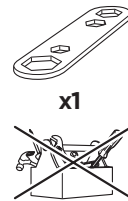
**B**

x1

6 Nm

