

Kit 3112

LAND ROVER LR3 w/Factory Track, 5-dr SUV, 05-09
LAND ROVER LR4 w/Factory Track, 5-dr SUV, 10-
HUMMER H3 w/Factory Track, 5-dr SUV, 05-10
HUMMER H3T w/Factory Track, 4-dr Pickup, 09-10

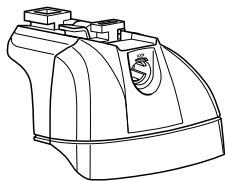

460R

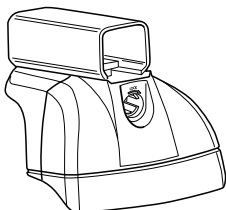
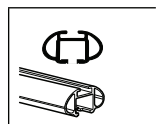

460

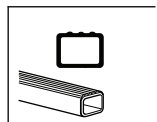

460R

460

1

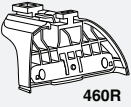

460R

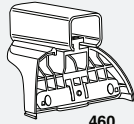

460

+

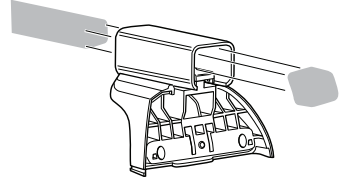
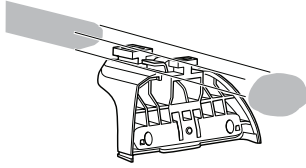

10 mm

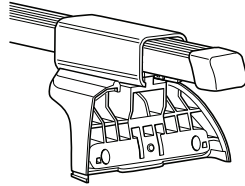
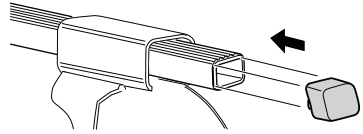
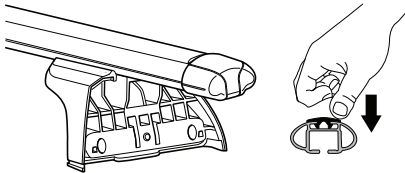
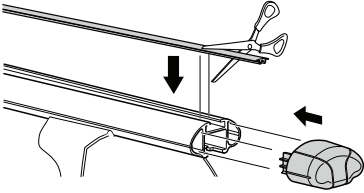
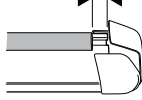

2



x4

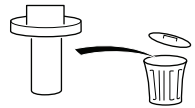
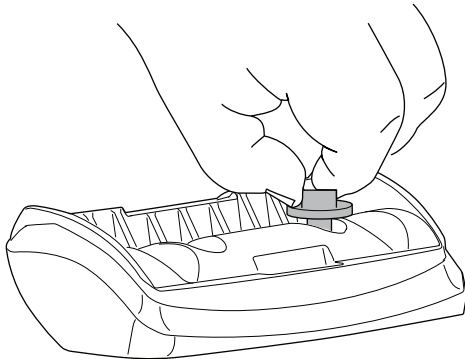

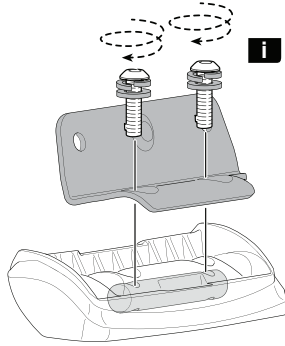
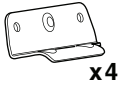
3**i****i**

- GB** Only a few turns
F Quelques tours uniquement
E Sólo algunas vueltas

4

LAND ROVER LR3 w/Factory Track, 5-dr SUV, 05-09
LAND ROVER LR4 w/Factory Track, 5-dr SUV, 10–

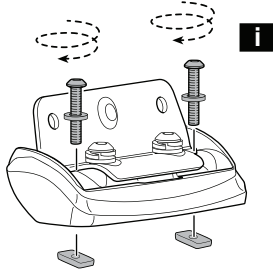
**i****i**

- GB** Only a few turns
F Quelques tours uniquement
E Sólo algunas vueltas

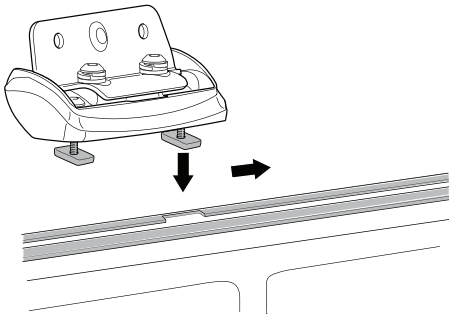
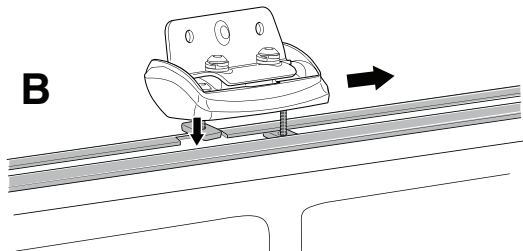
A**B**

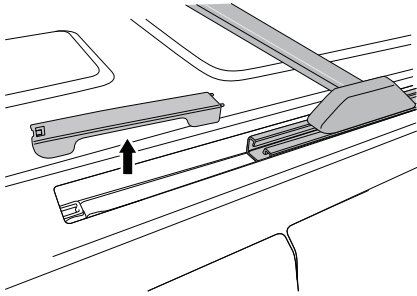
4
HUMMER H3 w/Factory Track, 5-dr SUV, 05-10
HUMMER H3T w/Factory Track, 4-dr Pickup, 09-10

- GB** Remove factory racks.
F Retirez les barres installées en usine.
E Para sacar el portacargas de fábrica.

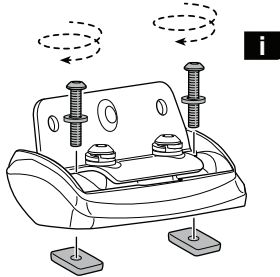
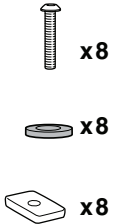
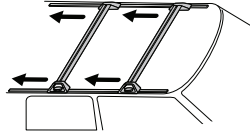

- i** **GB** Only a few turns
F Quelques tours uniquement
E Sólo algunas vueltas

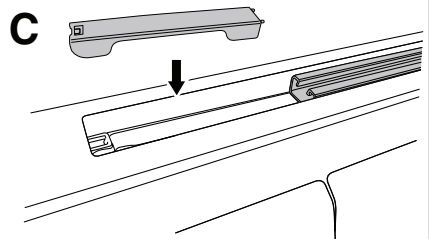
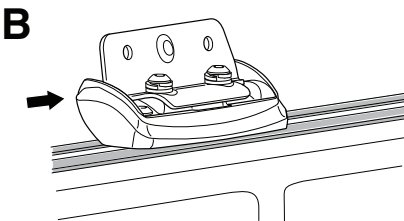
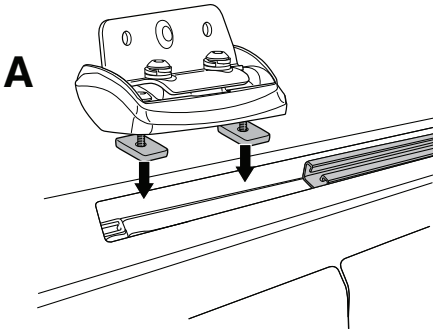

5

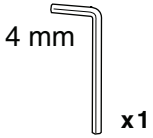

A

24" – 28" / 610 – 711 mm

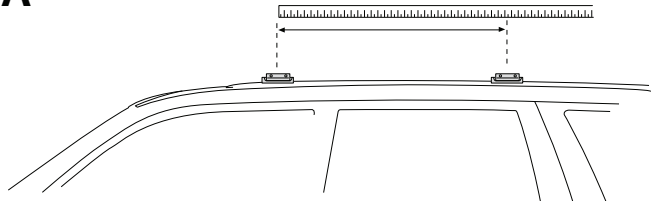

B

2.5 Nm
1.8 Ft.Lb

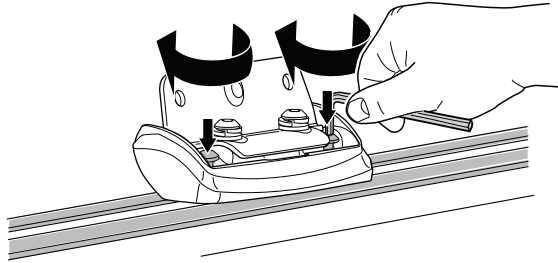

6

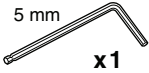

A

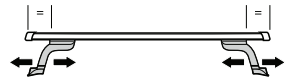

6 Nm
4.4 Ft.Lb

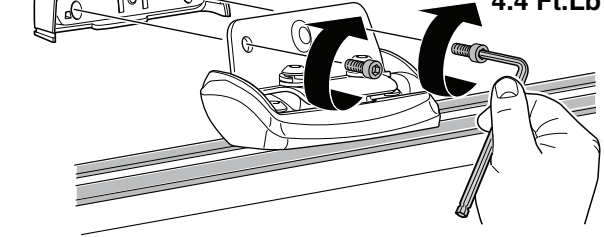

B

2.5 Nm
1.8 Ft.Lb

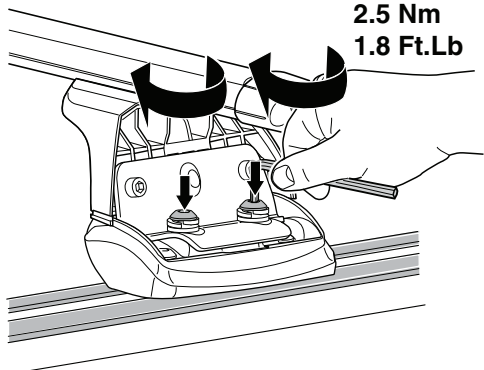

7



x1

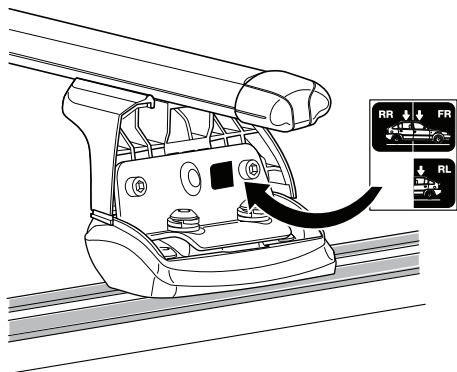

8



x4



x4

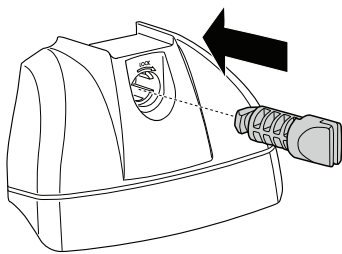

9

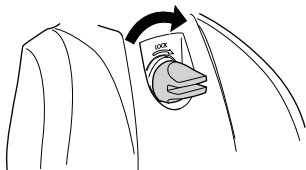
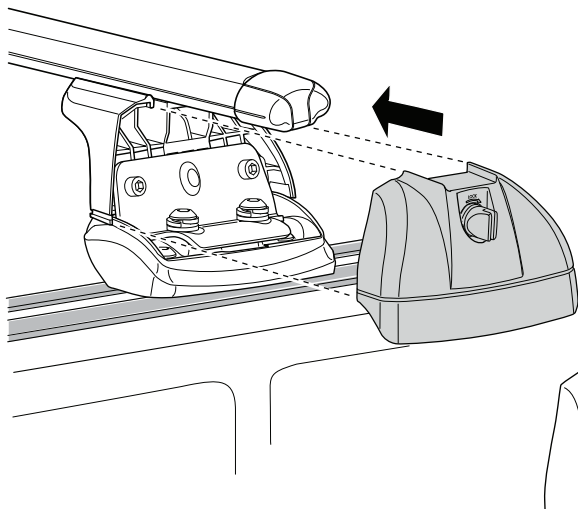

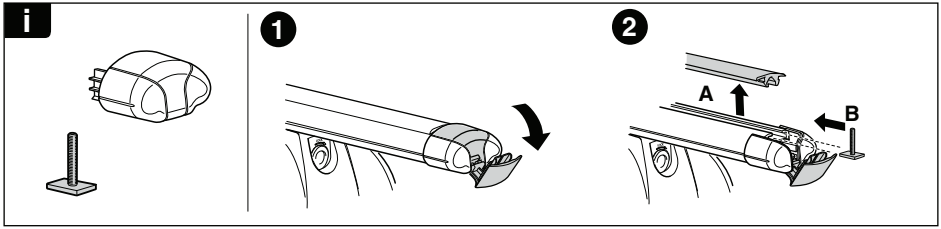
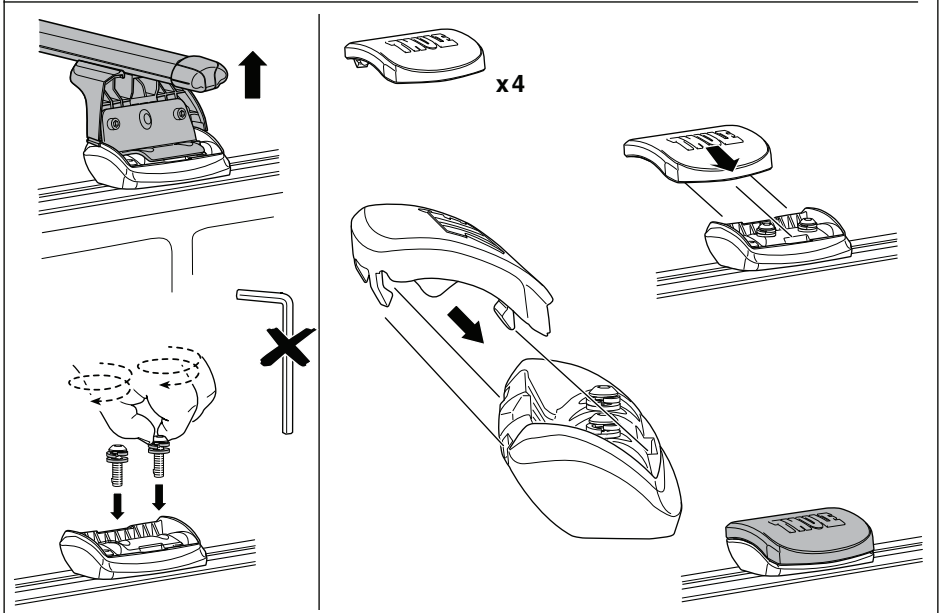
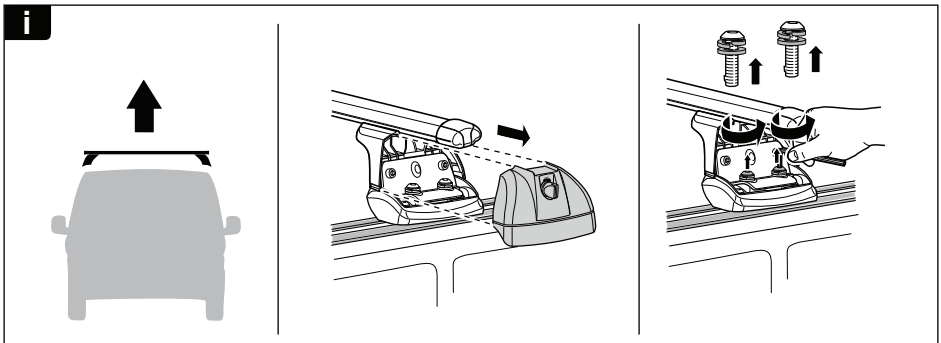

THULE
SWEDEN
**ONE
KEY
SYSTEM**

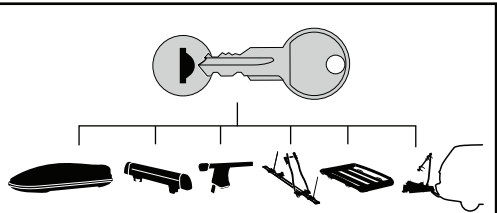

- 512** (x2)
- 544** (x4)
- 596** (x6)
- 588** (x8)