

Kit 3054

CITROËN Jumper, 4-dr Van, 95-01, 02-06

FIAT Ducato, 4-dr Van, 95-01, 02-06

IVECO Daily, 4-dr Van, 99–

PEUGEOT Boxer, 4-dr Van, 95-01, 02-06

This Kit is only for vehicles with fixpoint mounting.

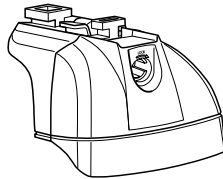

460R
753

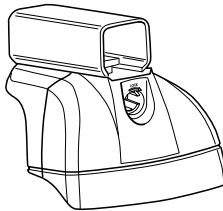
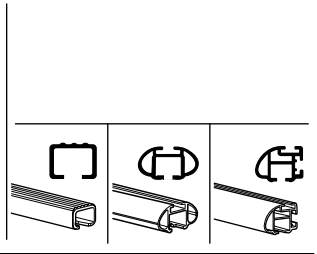

460

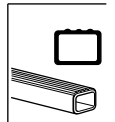

6 kg / 13 lbs + xx kg / xx lbs =

Max. 100 kg
Max. 220 lbs

9 kg / 20 lbs + xx kg / xx lbs =

Max. 150 kg
Max. 330 lbs

12 kg / 26 lbs + xx kg / xx lbs =

Max. 200 kg
Max. 440 lbs

THULE Kit XXXX

80 km/h 50 Mph 130 km/h 80 Mph
40 km/h 25 Mph
km/h Mph

A **B** **C**

09 x 4

67 x 4

50030
20 mm x 4

30154 x 4

x 4

Kit



753



x4



x4



x4



x8

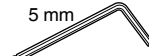

x1



x4



x1

460R

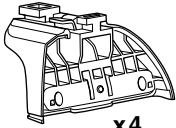

x4



x4



x4



x8

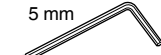

x1



x4

460

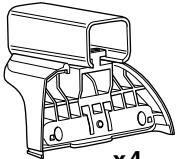

x4



x4



x4



x8

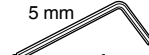

x1



x4

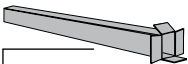

x2



x2

17 mm



x2

23 mm



x2

23 mm



x2



x2

17 mm

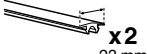

x2

23 mm



x2

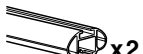

x2



x2



x4

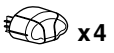

x4



x4

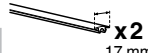

x2

25 mm



x2



x2



x2



x4



x4



x1

5 mm

1

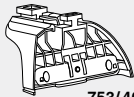

753/460R

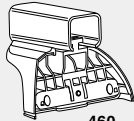

460

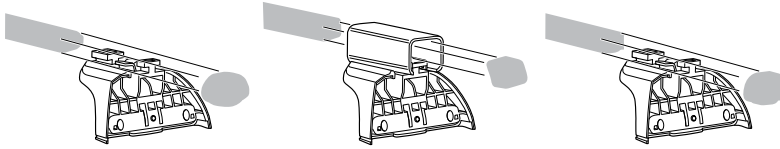

x4

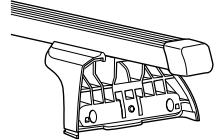
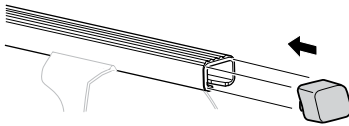

x4

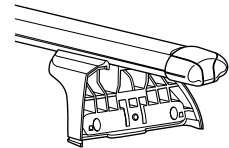
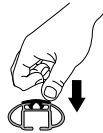
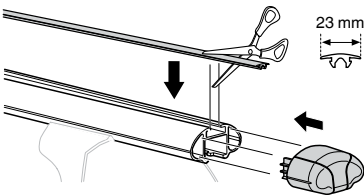

x4

x4

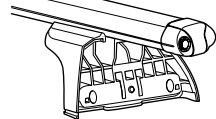
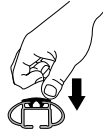
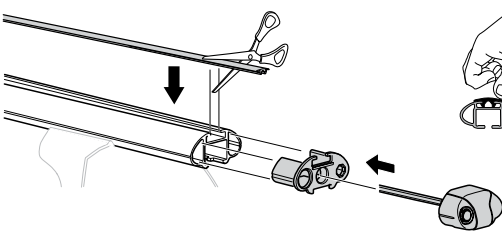

x4

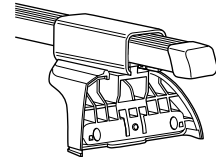
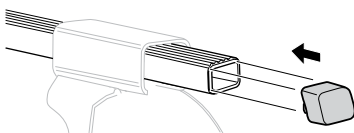

x2

x2

x4

x4

x1
5 mm

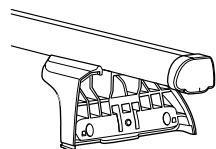
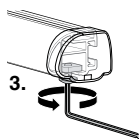
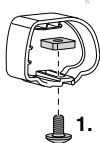
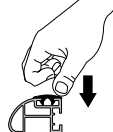
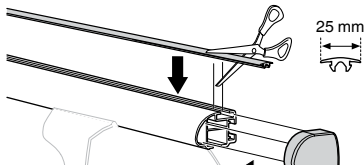

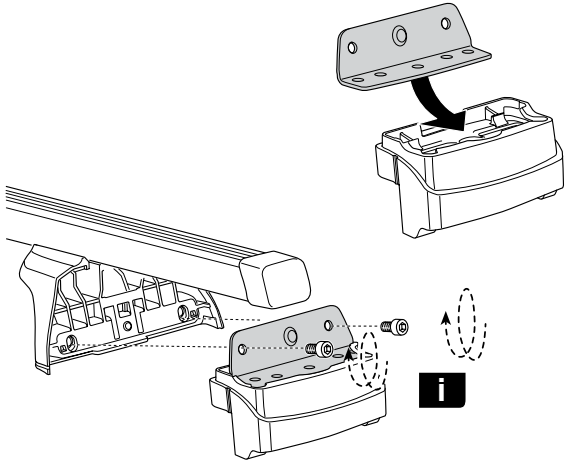
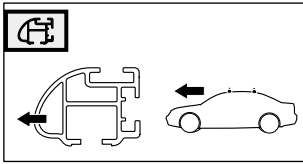
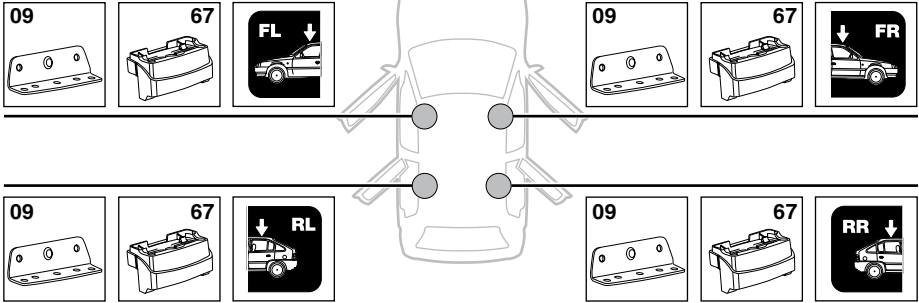
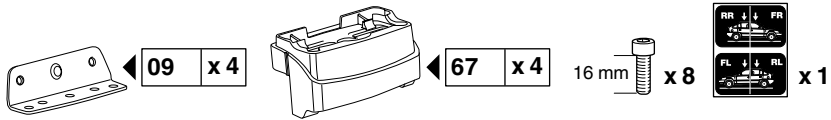
2**i**

- GB** Only a few turns
- D** Nur wenige Umdrehungen
- F** Quelques tours uniquement
- NL** Slechts enkele slagen
- I** Solo qualche giro
- E** Sólo algunas vueltas
- PT** Noções básicas
- S** Endast några varv
- FIN** Vain muutama kierros
- EST** Ainult mõni pööre
- LAT** Tikai dažī apgriezieni
- LIT** Tik keli pasukimai
- PL** Wystarczy kilka obrotów
- RU** Достаточно нескольких оборотов
- CZ** Pouze několik otáček
- SK** Len niekoľko otáčok
- SLO** Le nekaj obratov

- HR** Samo nekoliko okreta
- HU** Csak néhány fordítás
- GR** Μόνο μερικές στροφές
- TR** Yalnız birkaç kez çevirm
- 中文** 只有几个转向
- 한국어** 두 세번만
- 日本語** 数回転のみ
- ไทย** หมุนเพียงไม่กี่รอบ

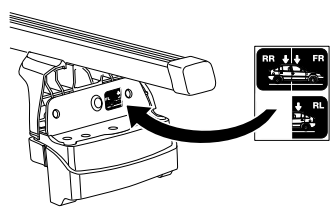

3

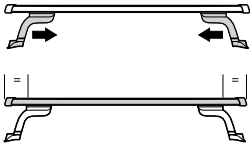
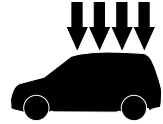
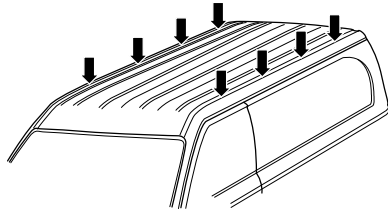
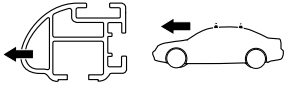

A

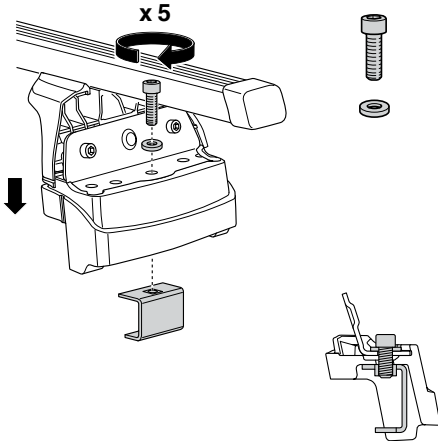

B

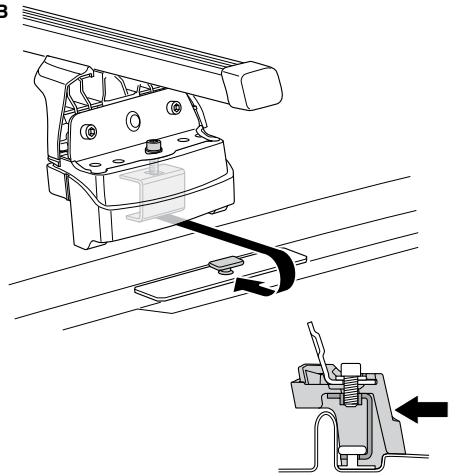

C

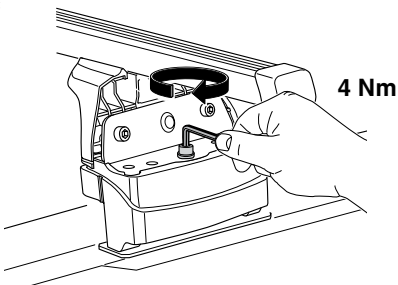

D

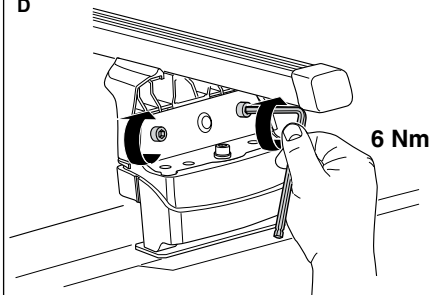

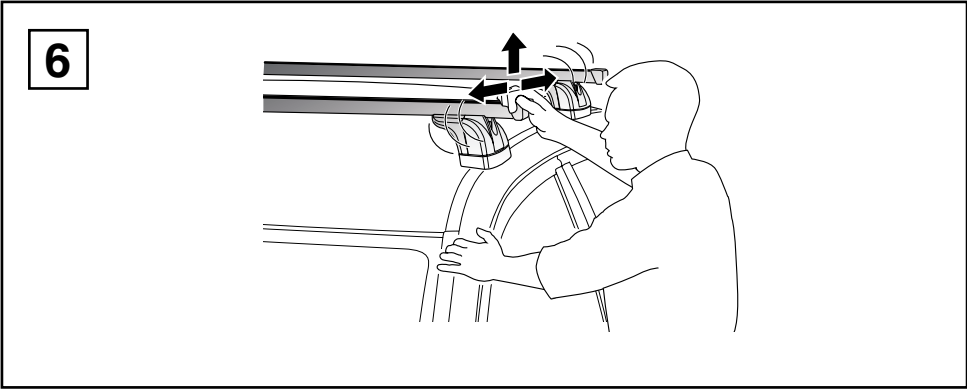
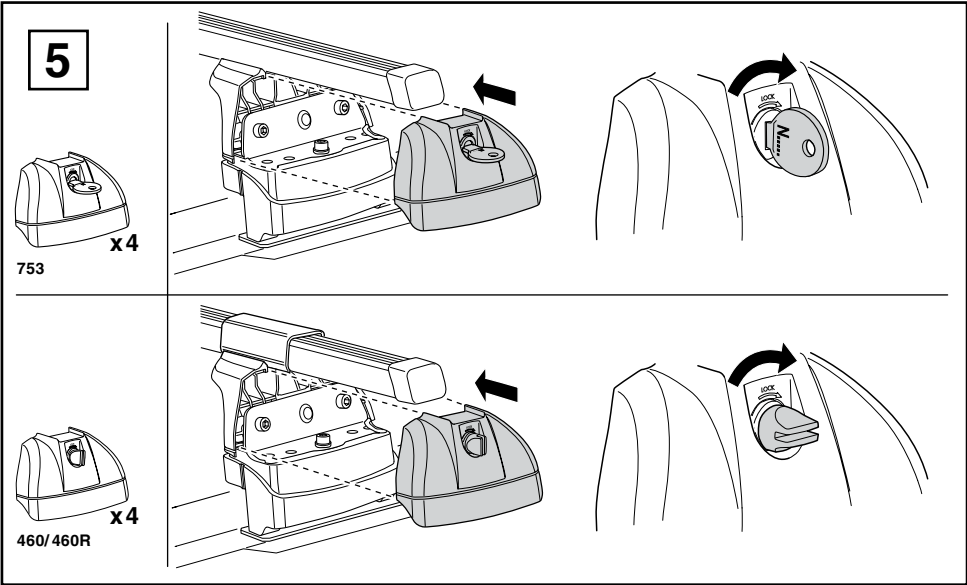
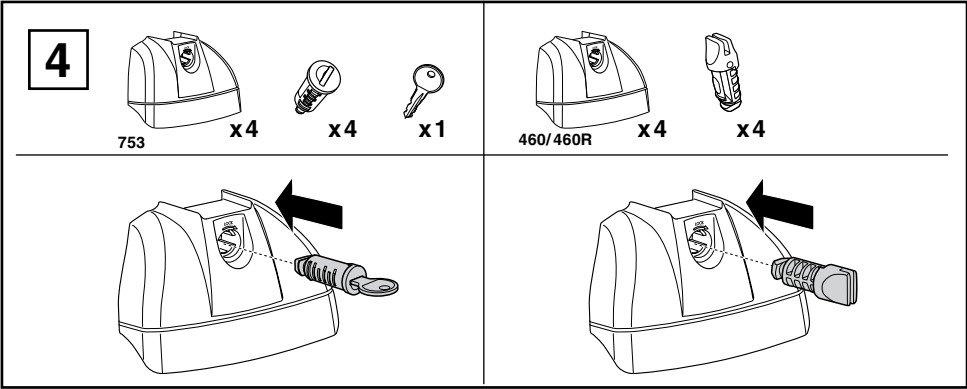

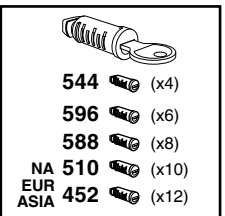
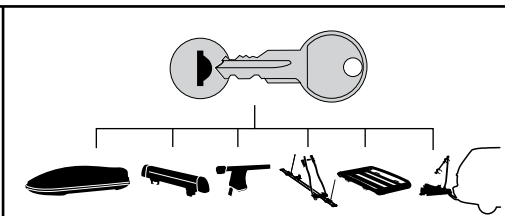
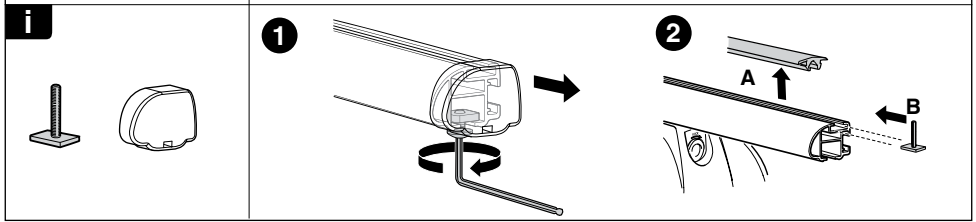
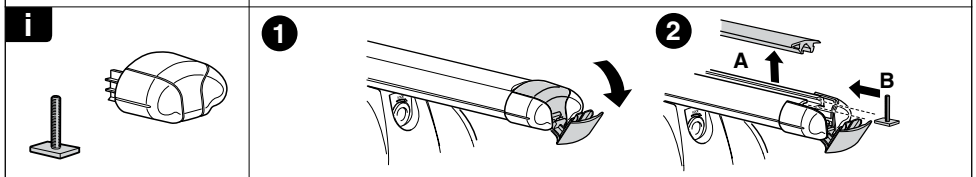
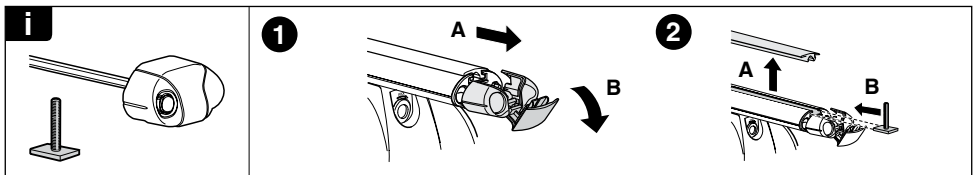
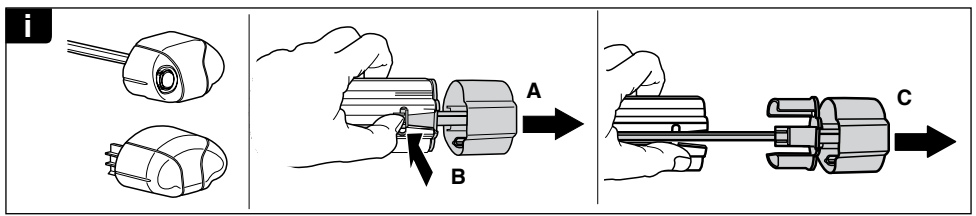
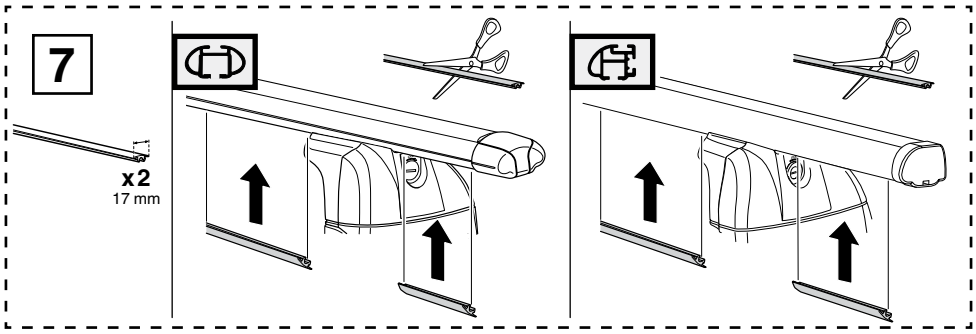

WW ▶ Thule Sweden AB, Box 69, 330 33 Hillerstorp, SWEDEN
 NA ▶ Thule Inc., 42 Silvermine Road, Seymour, Connecticut 06483, USA

info@thule.com
 customer.service@thule.com

www.thule.com