

Kit 3043

TOYOTA Hi Ace, 5-dr Van, 96-06, 07-

This Kit is only for vehicles with fixpoint mounting.

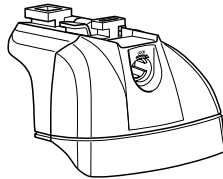

460R
753

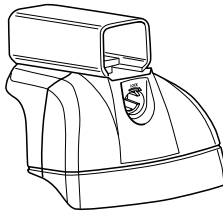
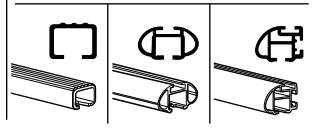

460

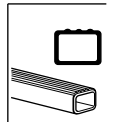

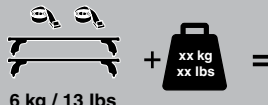

 6 kg / 13 lbs + xx kg xx lbs = **Max. 100 kg**
Max. 220 lbs



 9 kg / 20 lbs + xx kg xx lbs = **Max. 150 kg**
Max. 330 lbs



 12 kg / 26 lbs + xx kg xx lbs = **Max. 200 kg**
Max. 440 lbs

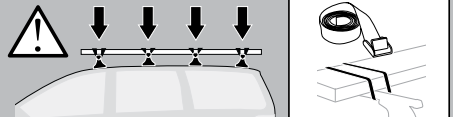

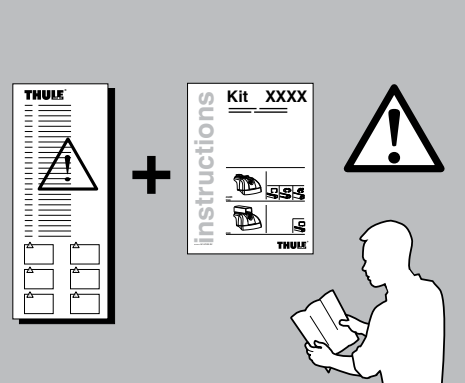

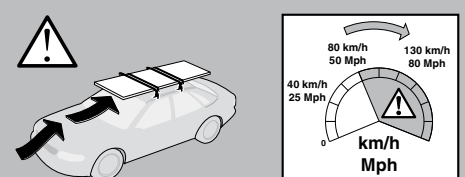

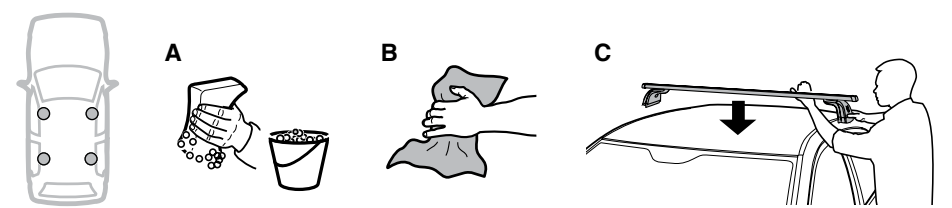

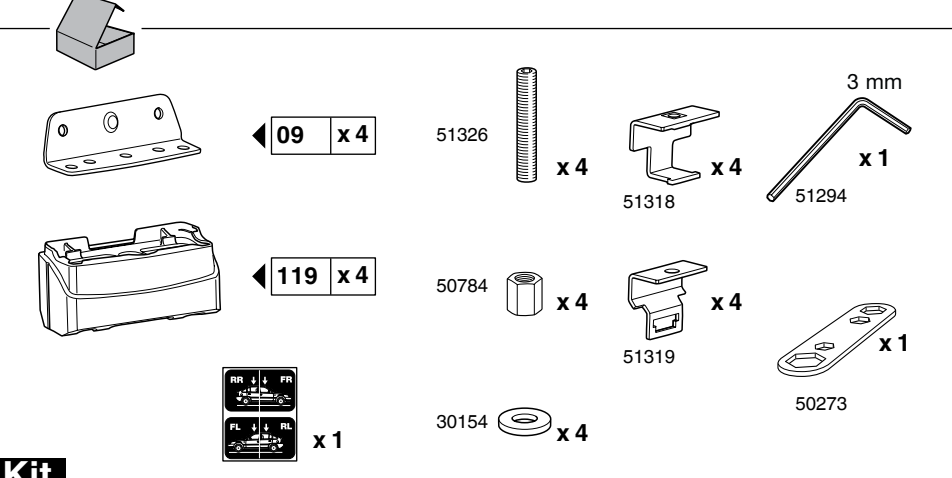

Kit

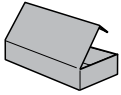

753

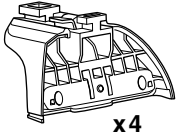

x4



x4



x4



x8

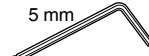

x1



x4



x1

460R

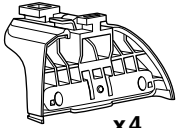

x4



x4



x4



x8

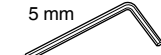

x1



x4

460

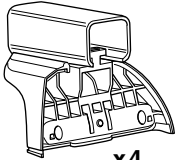

x4



x4



x4



x8

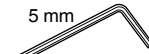

x1



x4

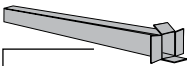

x2



x2



x2



x2



x2



x2



17 mm

x2



23 mm

x2



23 mm

x2

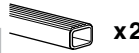

25 mm

x2



23 mm

x2



x4

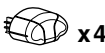

x4



x4

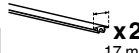

17 mm

x2

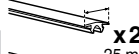

25 mm

x2



x2

x4

x4



x1

5 mm

1

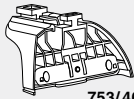

753/460R

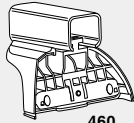

460

+

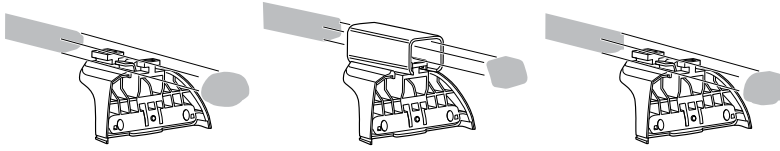

x4

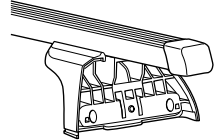
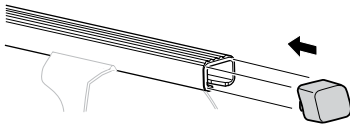

x4

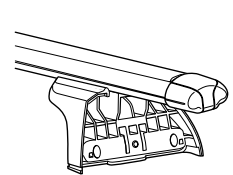
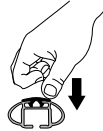
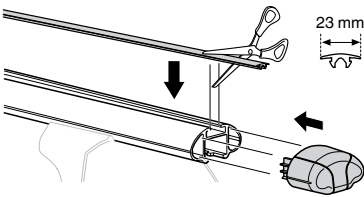

x4

x4

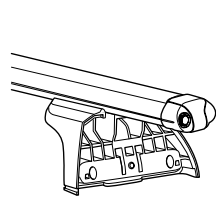
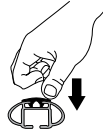
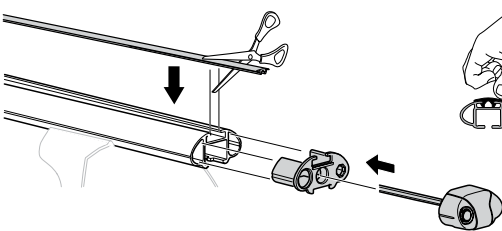

x4

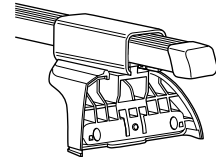
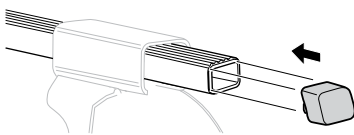

x2

x2

x4

x4

x1
5 mm

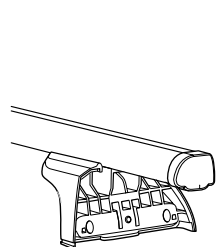
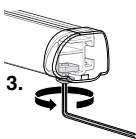
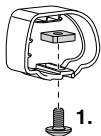
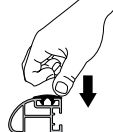
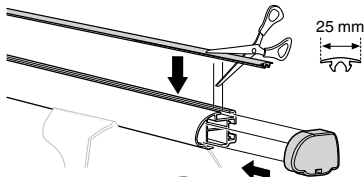

2

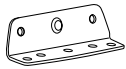

◀ 09 x 4



◀ 119 x 4



16 mm x 8



x 1

09

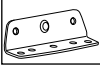

119

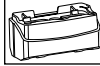

09

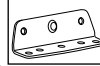

119

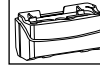

09

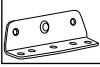

119

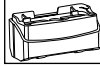

09

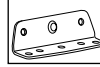

119

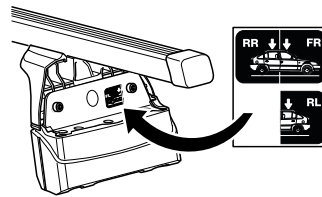
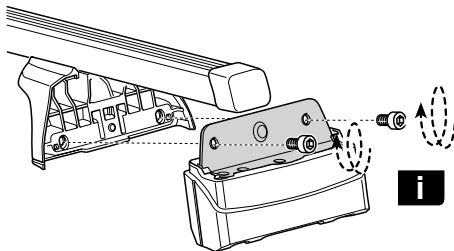
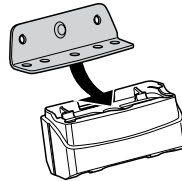
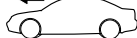
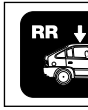
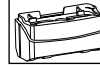

i

- GB** Only a few turns
- D** Nur wenige Umdrehungen
- F** Quelques tours uniquement
- NL** Slechts enkele slagen
- I** Solo qualche giro
- E** Sólo algunas vueltas
- PT** Noções básicas
- S** Endast några varv
- FIN** Vain muutama kierros

- EST** Ainult mõni pööre
- LAT** Tikai dažī apgriezieni
- LIT** Tik keli pasukimai
- PL** Wystarczy kilka obrotów
- RU** Достаточно нескольких оборотов
- CZ** Pouze několik otáček
- SK** Len niekoľko otáčok
- SLO** Le nekaj obratov

- HR** Samo nekoliko okreta
- HU** Csak néhány fordítás
- GR** Μόνο μερικές στροφές
- TR** Yalnız birkaç kez çevirm
- 中文** 只有几个转向
- 한국어** 두 세번만
- 日本語** 数回転のみ
- ไทย** หมุนเพียงไม่กี่รอบ

3

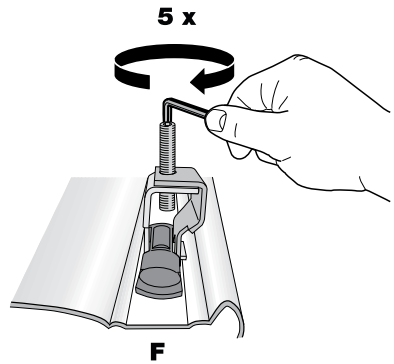
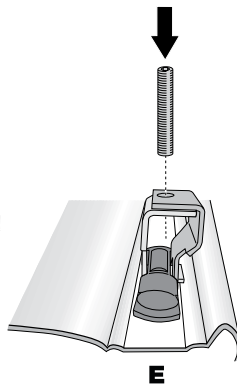
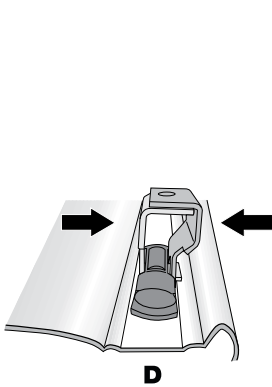
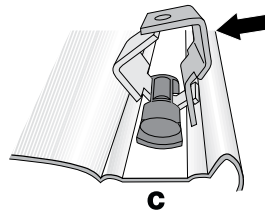
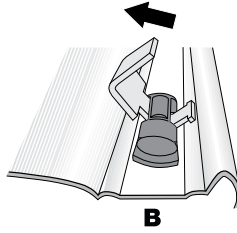
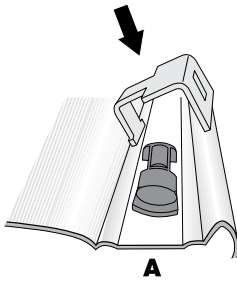
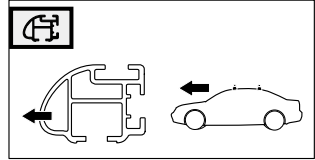
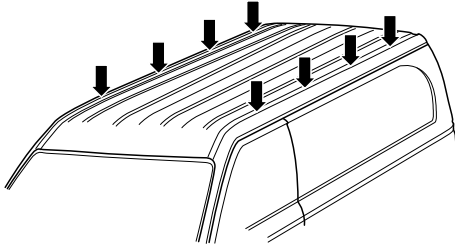
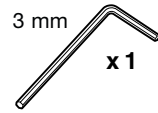
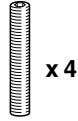
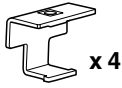

4

x 4



x 4



x 1

5 mm



x 1

3 mm



x 1

A

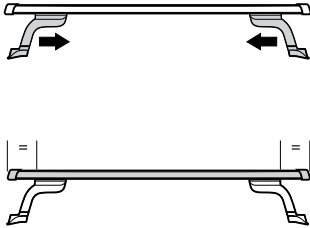

B

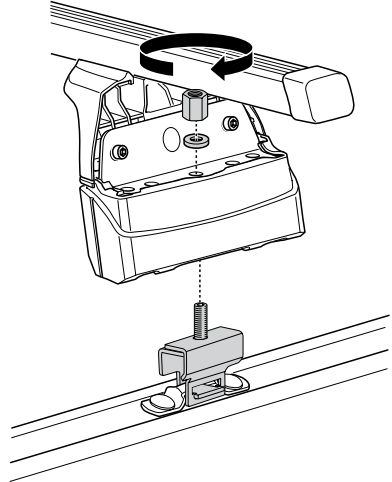

C

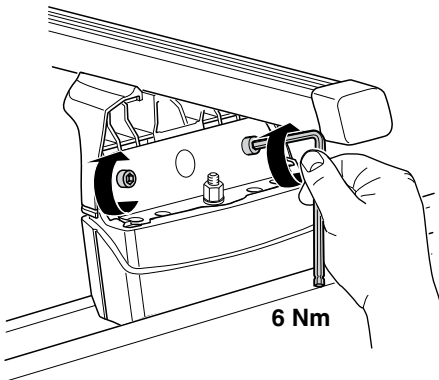

6 Nm

D

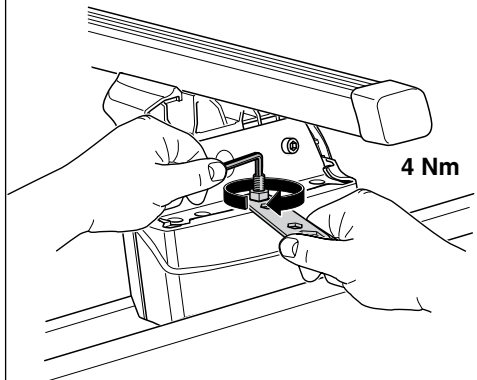

4 Nm

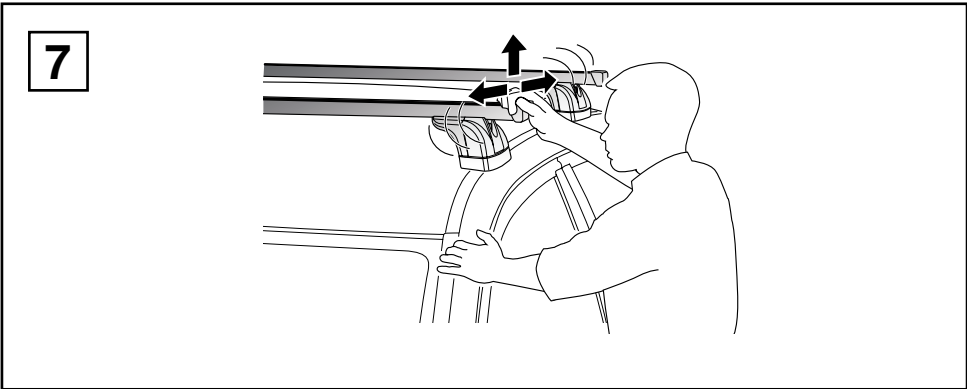
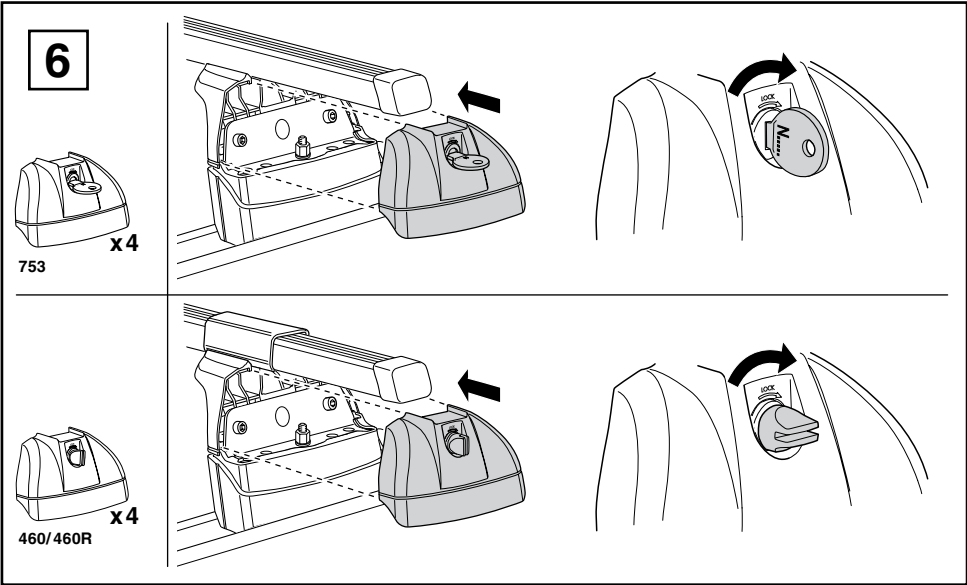
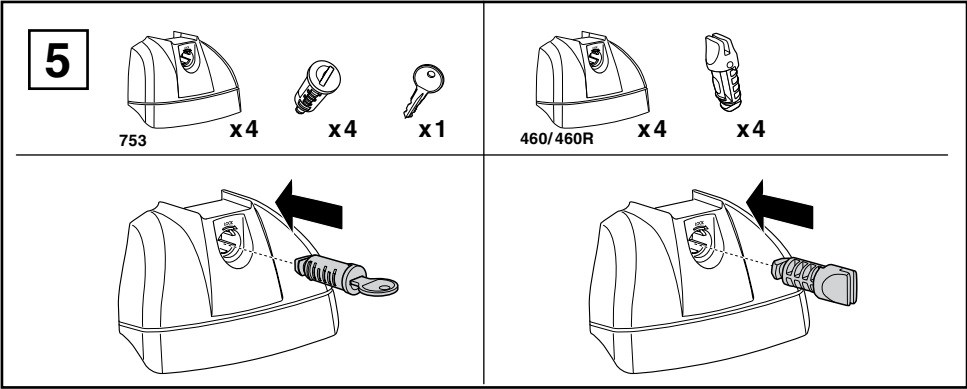

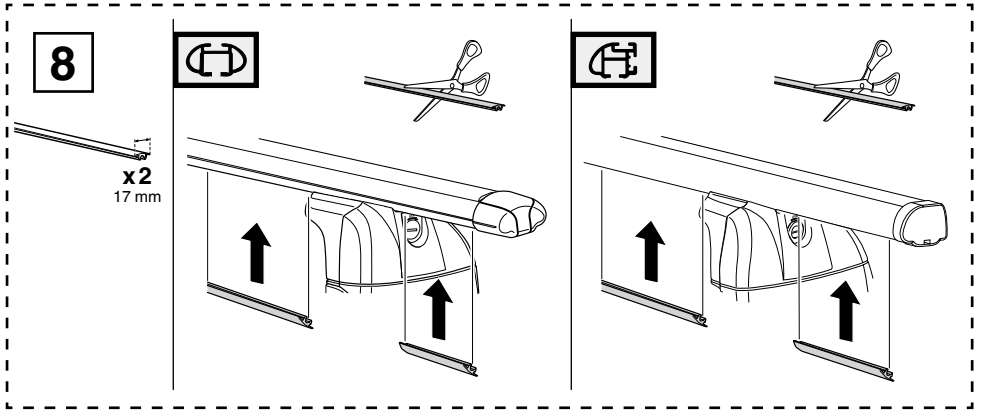

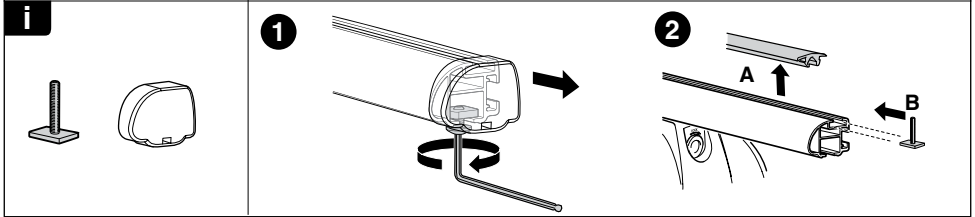
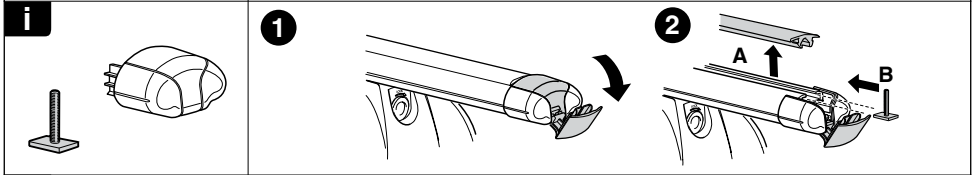
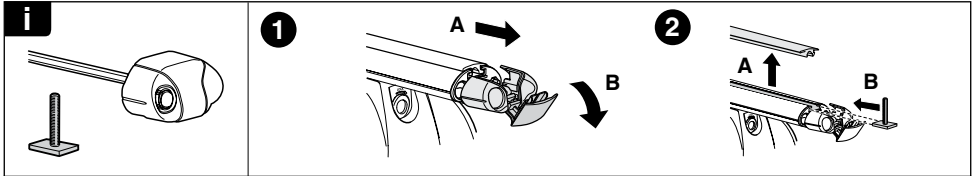
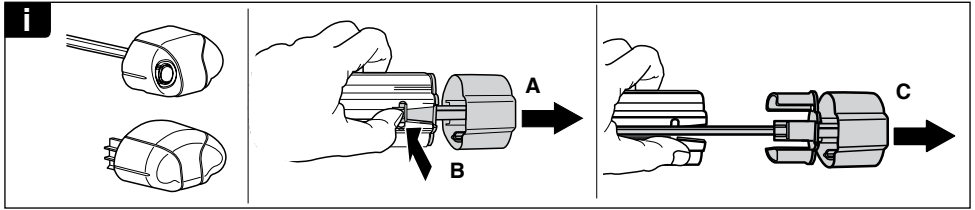

THULE
SWEDEN

**ONE
KEY
SYSTEM**

544 (x4)

596 (x6)

588 (x8)

NA 510 (x10)

EUR 452 (x12)

WW ▶ Thule Sweden AB, Box 69, 330 33 Hillerstorp, SWEDEN
 NA ▶ Thule Inc., 42 Silvermine Road, Seymour, Connecticut 06483, USA

info@thule.com
 customer.service@thule.com

www.thule.com