

Kit 1637

HYUNDAI H-1, 5-dr Van, 08-*

HYUNDAI iLoad, 5-dr Van, 08-**

HYUNDAI iMax, 5-dr Bus, 08-**

HYUNDAI Starex, 5-dr Van, 08-*

* with dual sliding doors

** with dual sliding doors (Asia)

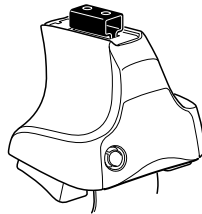

754 Rapid System
480R Rapid Traverse (North America)

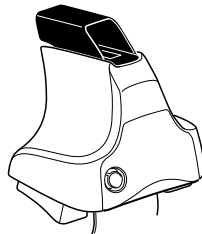
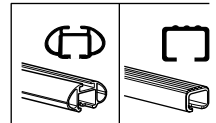

480 Traverse (North America)

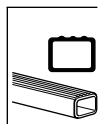

754 Rapid System
480R Rapid Traverse (North America)

754 Rapid System
480R Rapid Traverse (North America)

480 Traverse (North America)

(North America)

969 x 2
971 x 2
1156 x 2
293 x 4
x 1

1



2



754 Rapid System
480R Rapid Traverse
(North America)

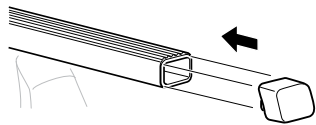
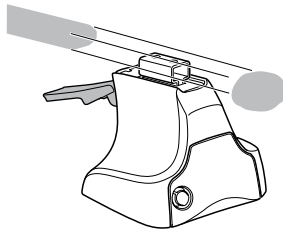

x4

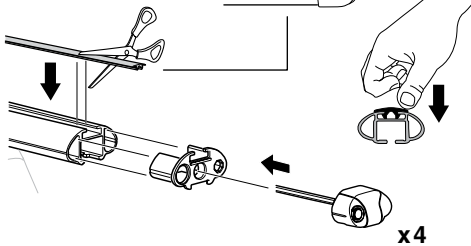
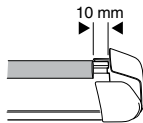

x4

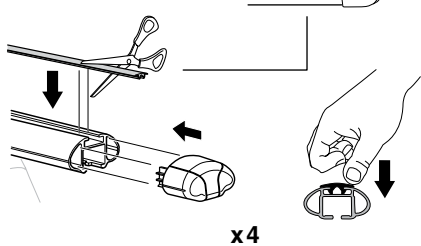
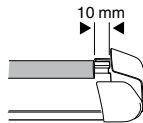
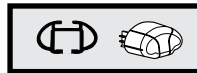

x4



480 Traverse
(North America)

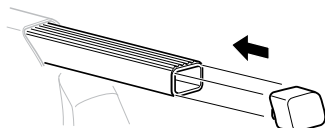
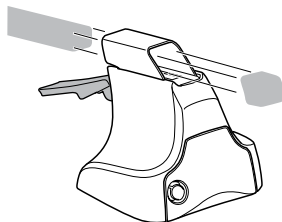

x4

3



754 Rapid System

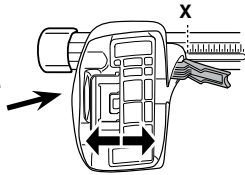

	X
HYUNDAI H-1, 5-dr Van, 08-	59,5
HYUNDAI iLoad, 5-dr Van, 08-	59,5
HYUNDAI iMax, 5-dr Bus, 08-	59,5
HYUNDAI Starex, 5-dr Van, 08-	59,5

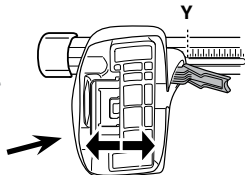

	Y
HYUNDAI H-1, 5-dr Van, 08-	55,5
HYUNDAI iLoad, 5-dr Van, 08-	55,5
HYUNDAI iMax, 5-dr Bus, 08-	55,5
HYUNDAI Starex, 5-dr Van, 08-	55,5

3



480R Rapid Traverse



480 Traverse

(North America)

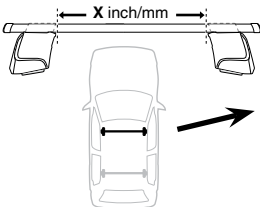

	X inch	X mm
HYUNDAI H-1, 5-dr Van, 08-	49"	1246 mm
HYUNDAI iLoad, 5-dr Van, 08-	49"	1246 mm
HYUNDAI iMax, 5-dr Bus, 08-	49"	1246 mm
HYUNDAI Starex, 5-dr Van, 08-	49"	1246 mm

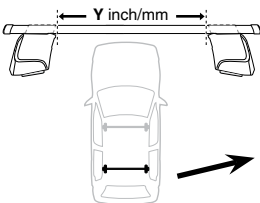

	Y inch	Y mm
HYUNDAI H-1, 5-dr Van, 08-	47 1/2"	1206 mm
HYUNDAI iLoad, 5-dr Van, 08-	47 1/2"	1206 mm
HYUNDAI iMax, 5-dr Bus, 08-	47 1/2"	1206 mm
HYUNDAI Starex, 5-dr Van, 08-	47 1/2"	1206 mm

4

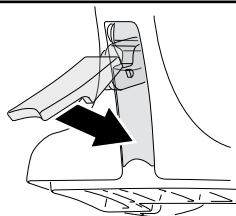

5

HYUNDAI H-1, 5-dr Van, 08-
HYUNDAI iLoad, 5-dr Van, 08-
HYUNDAI iMax, 5-dr Bus, 08-
HYUNDAI Starex, 5-dr Van, 08-

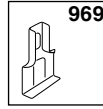
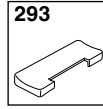
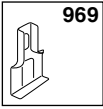
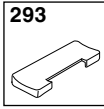
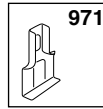
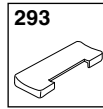
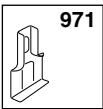
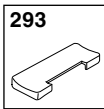
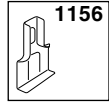
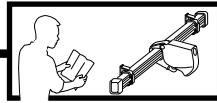
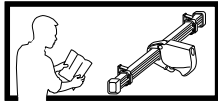
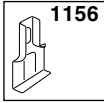
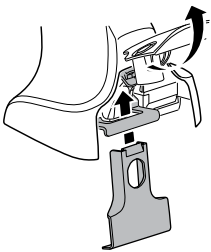
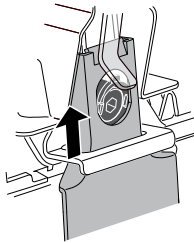
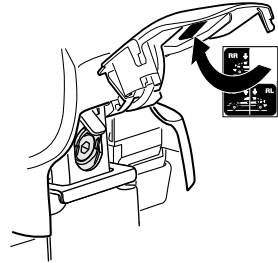
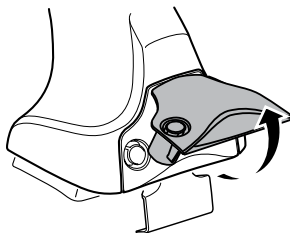
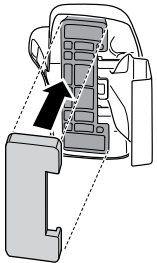
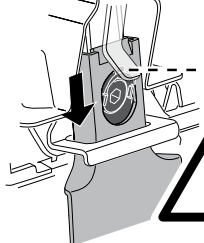
**KIT 1475****KIT 1475****A****B****C**

6

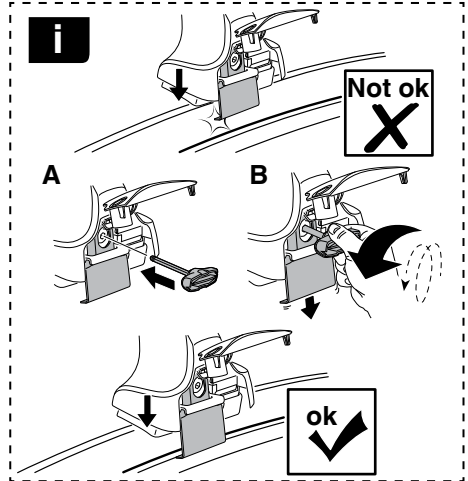
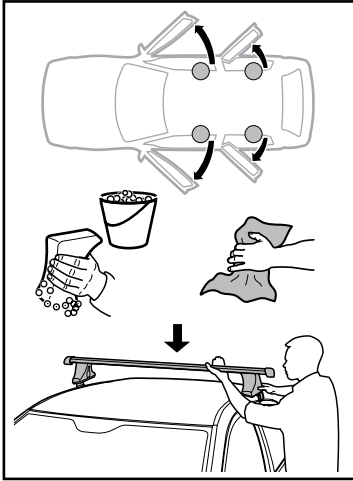

	X mm	Y mm	Z mm	X inch	Y inch	Z inch
HYUNDAI H-1, 5-dr Van, 08-	380 mm	1910 mm	120 mm	15"	75 1/4"	4 3/4"
HYUNDAI iLoad, 5-dr Van, 08-	380 mm	1910 mm	120 mm	15"	75 1/4"	4 3/4"
HYUNDAI iMax, 5-dr Bus, 08-	380 mm	1910 mm	120 mm	15"	75 1/4"	4 3/4"
HYUNDAI Starex, 5-dr Van, 08-	380 mm	1910 mm	120 mm	15"	75 1/4"	4 3/4"

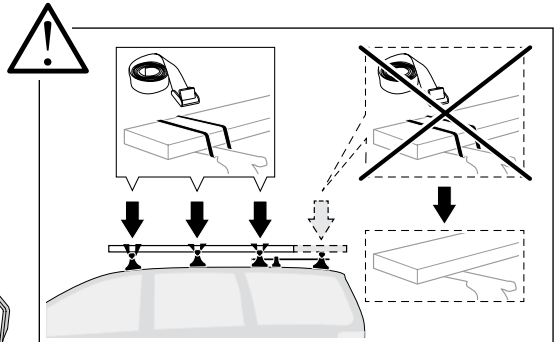
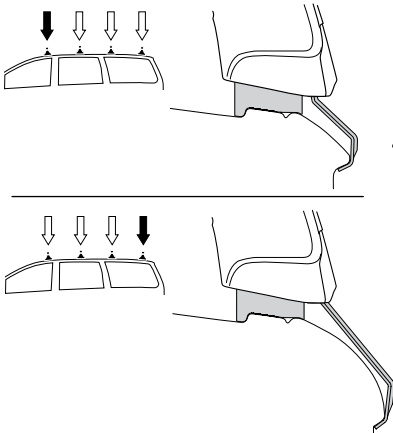
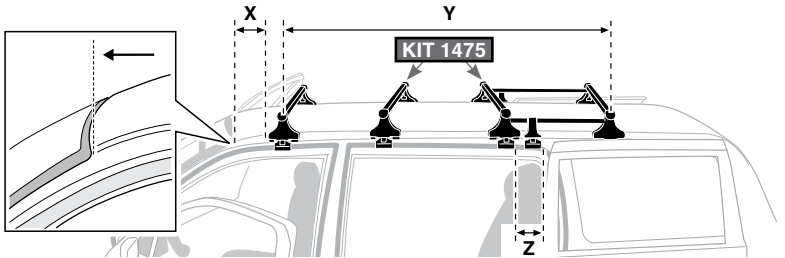

7

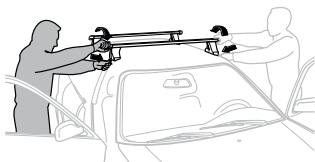

GB/US	Tighten alternately
D	Die Schrauben abwechselnd anziehen
F	Serrer alternativement chaque côté
NL	Afwisselend aan de linker- en de rechterkant aandraaien
I	Alternare il serraggio delle viti
E	Apertar alternativamente
PT	Aperte alternadamente
S	Dra åt växelvis
FIN	Kierrä vuorotellen
EST	Pinguldage vaheldumisi
LAT	Pielveiciet pamišus
LIT	Užsukinėkite pakaitomis
PL	Śruby dokręcaj naprzemiennie
RU	Затягивайте попеременно

CZ	Pokręťta bagażnika dokręcaj naprzemiennie.
SK	Dofahajte striedavo
SLO	Privijajte izmenično.
HR	Naizmjenočno zategnite
HU	Egymástól függetlenül szorítandó
GR	Σφιγίγτες εναλλάξ
TR	Dönüşümlü sıkın

中文 交替拧紧

한국어 번갈아 가며 조이십시오.

日本語 交互に締め付けてください。

ไทย ชันในแบบสลับ

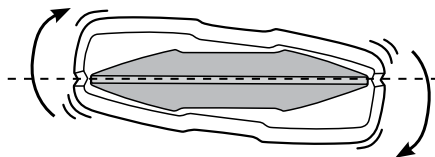
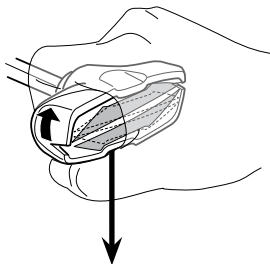
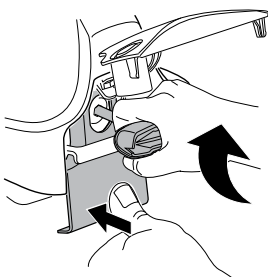
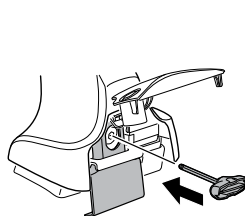

≈ 3 Nm

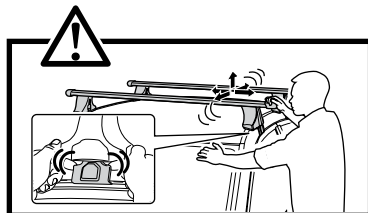
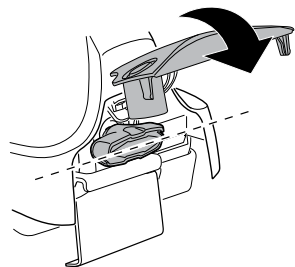

8



x1
17 mm

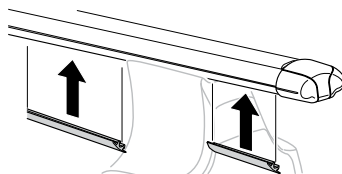
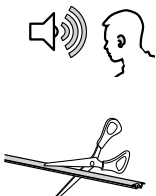

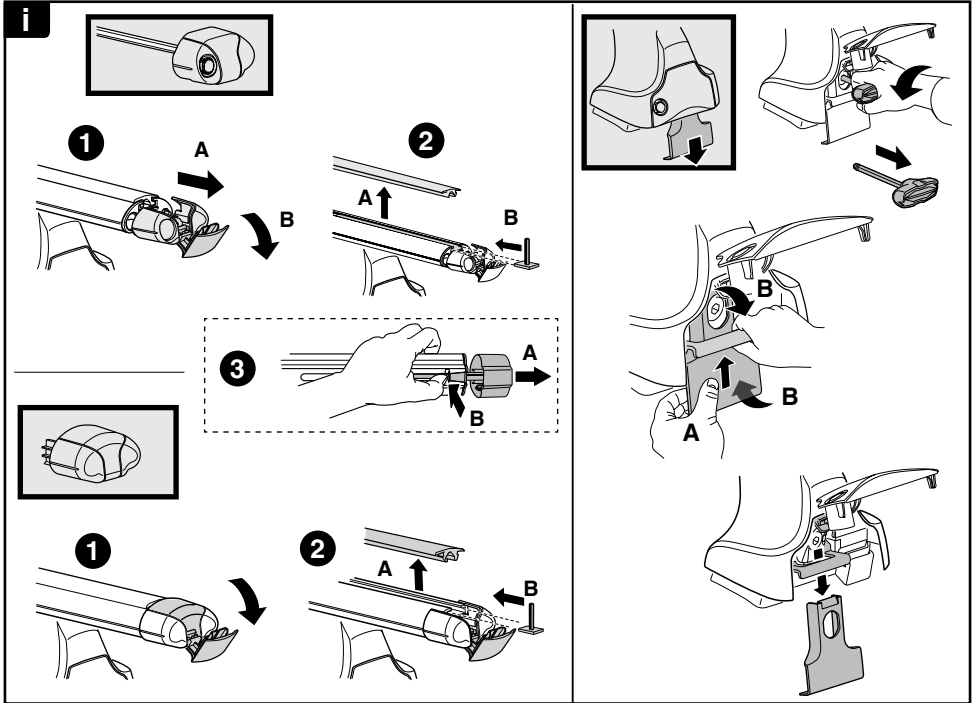

THULE
SWEDEN
**ONE
KEY
SYSTEM**

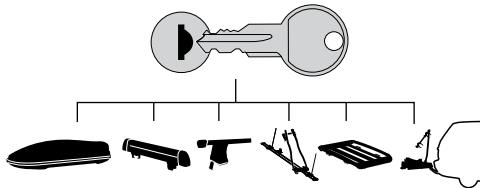

- 544** (x4)
- 596** (x6)
- 588** (x8)
- NA **510** (x10)
- EUR **452** (x12)
- ASIA

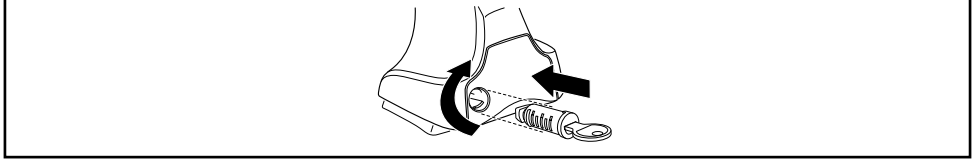

WW ▶ Thule Sweden AB, Box 69, 330 33 Hillerstorp, SWEDEN
NA ▶ Thule Inc., 42 Silvermine Road, Seymour, Connecticut 06483, USA

info@thule.com
customer.service@thule.com

 www.thule.com

www.thuleprofessional.com

info@thule.com
customer.service@thule.com

NA Thule Inc., 42 Silvermine Road, Seymour, Connecticut 06483, USA
SW Thule Sweden AB, Box 69, 330 33 Hillerstorp, SWEDEN

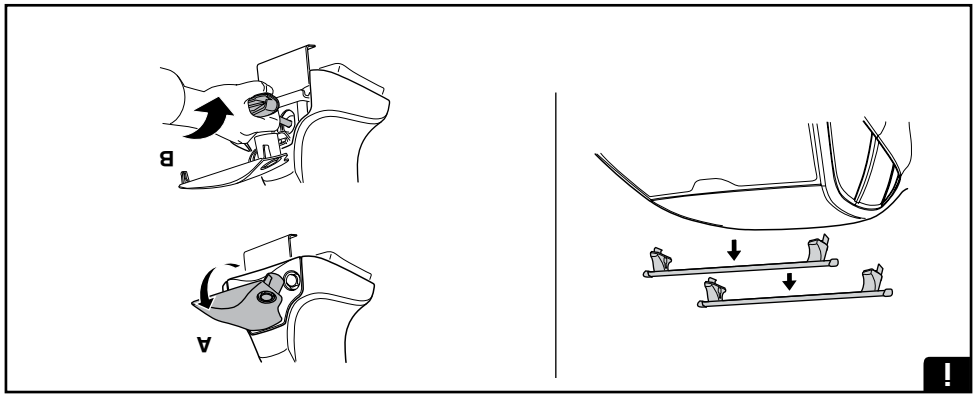
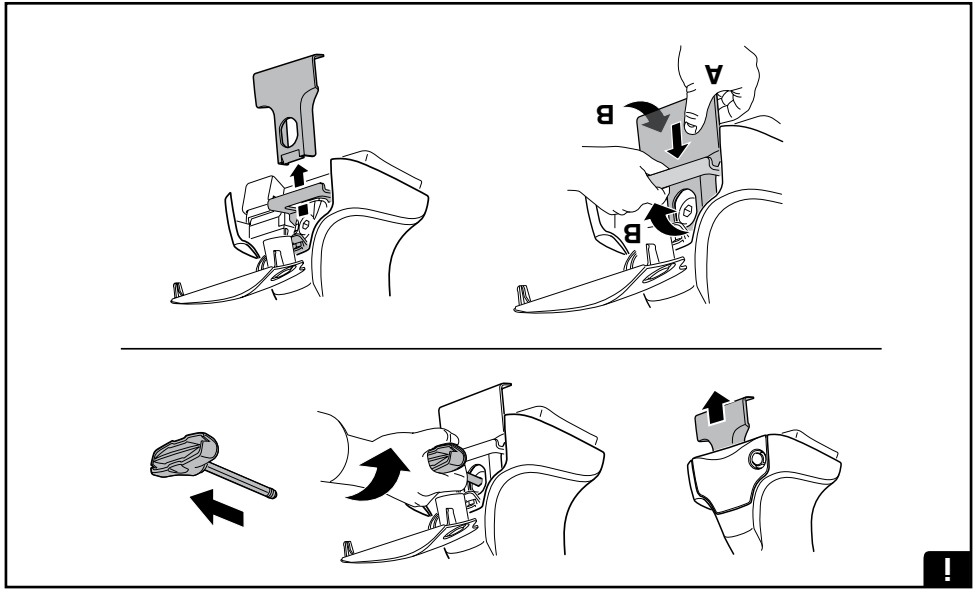

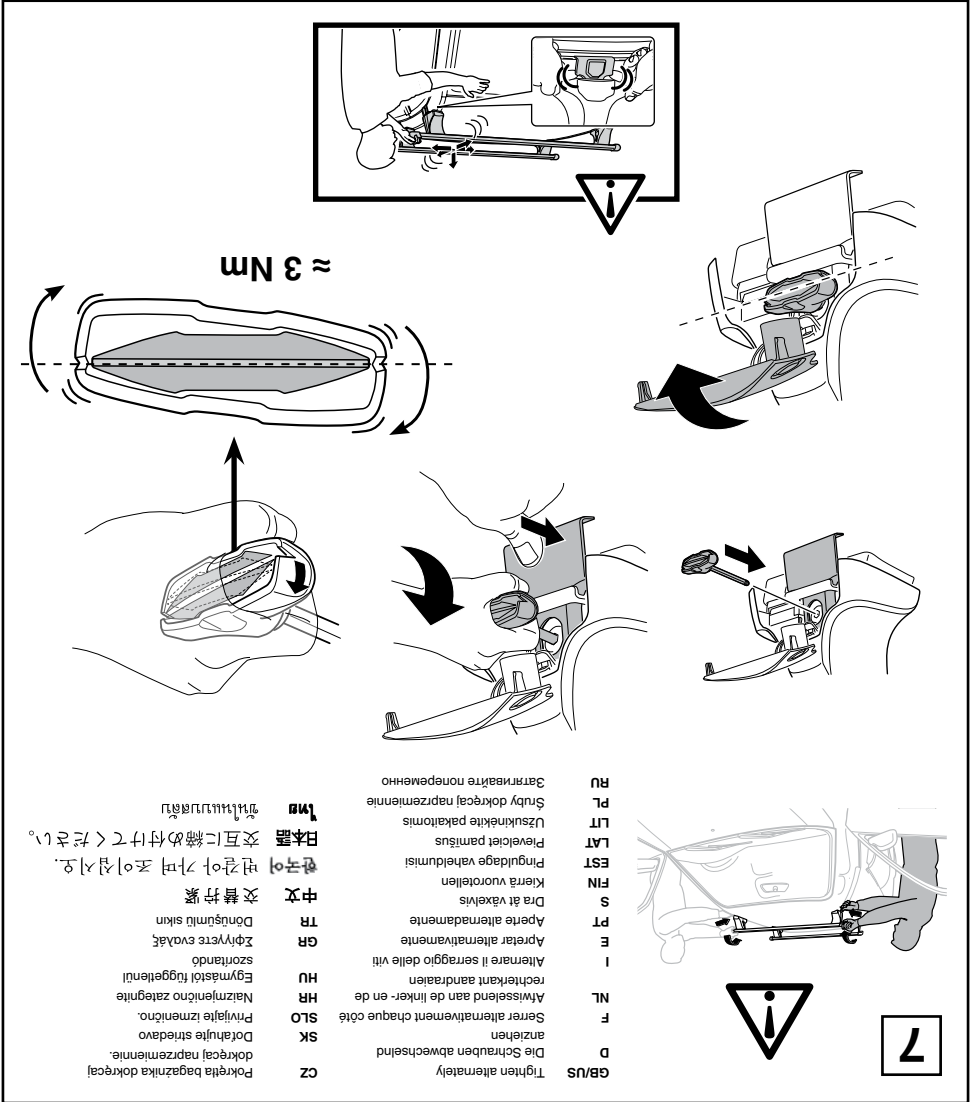
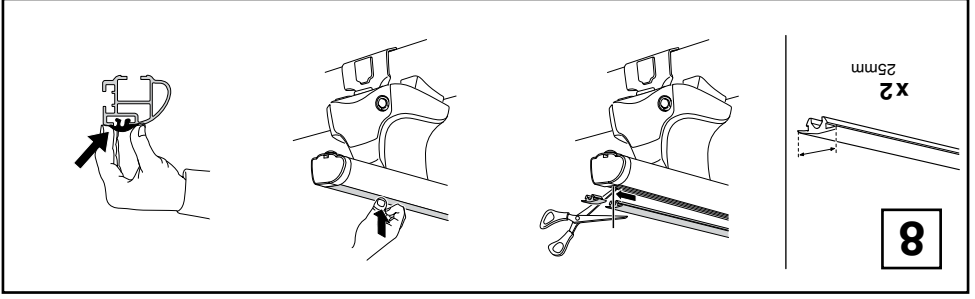

CZ Pokrétla bagazníka dokrécaj dokrécaj naprzemienie.
SK Dotiahnuť striedavo.
SLO Privajlje izmenično.
HR Naizmenično zatęgnite.
HU Egyenestőli fűggetlenül szorítandó.
GR Zpřilyerte evaóá.
TR Dönüşümü silkin.
中文 交替拧紧。
한국어 번갈아 가며 조이십시오.
日本語 交互に締め付けてください。
ไทย ไขน็อตสลับกัน

GB/US Tighten alternately.
D Die Schrauben abwechselnd anziehen.
F Serrer alternativement chaque côté.
NL Afwisselend aan de linker- en de rechterkant aandraaien.
I Alternare il serraggio delle viti.
E Aperte alternativamente.
PT Aperte alternadamente.
S Dra åt växelvis.
FIN Kierrä vuorotellen.
EST Pinguldage vaheldumisi.
LAT Pevicīet pārtibus.
LIT Užsukinkite pakalomis.
PL Śruby dokrecaj naprzemienno.
RU Затягивайте попеременно.

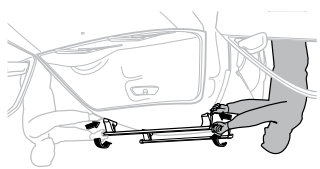

7

8

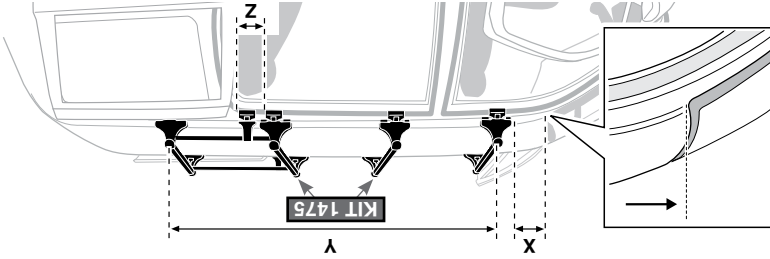
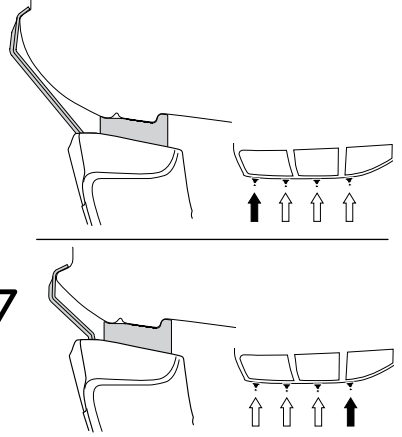
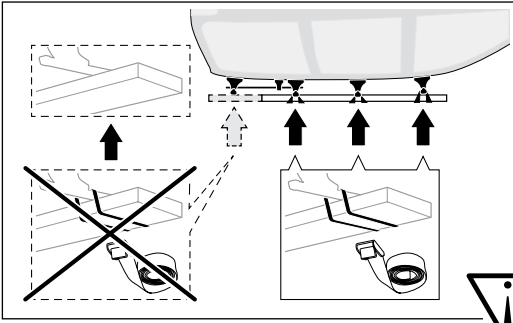

Model	X mm	Y mm	Z mm	X inch	Y inch	Z inch
HYUNDAI H-1, 5-dr Van, 08-	380 mm	1910 mm	120 mm	15"	75 1/4"	4 3/4"
HYUNDAI iLoad, 5-dr Van, 08-	380 mm	1910 mm	120 mm	15"	75 1/4"	4 3/4"
HYUNDAI iMax, 5-dr Bus, 08-	380 mm	1910 mm	120 mm	15"	75 1/4"	4 3/4"
HYUNDAI Starex, 5-dr Van, 08-	380 mm	1910 mm	120 mm	15"	75 1/4"	4 3/4"

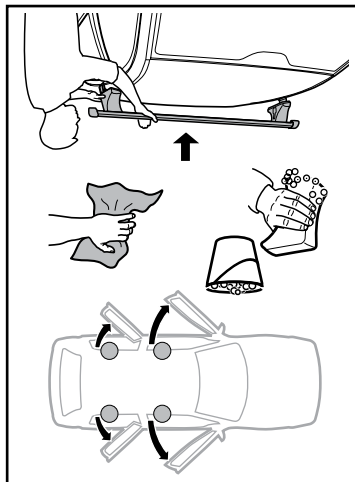
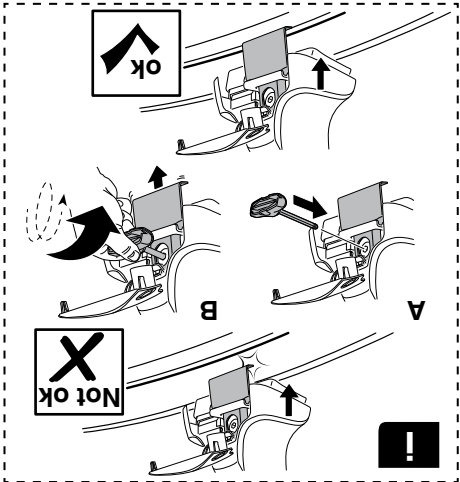

6

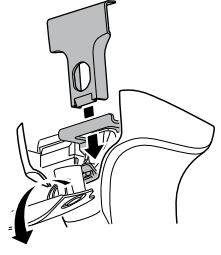
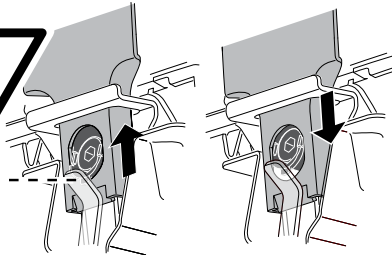
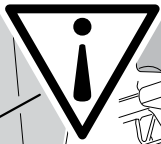
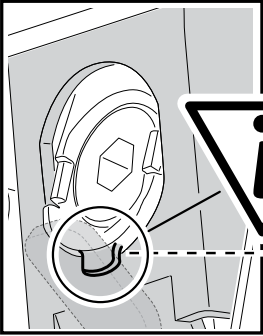
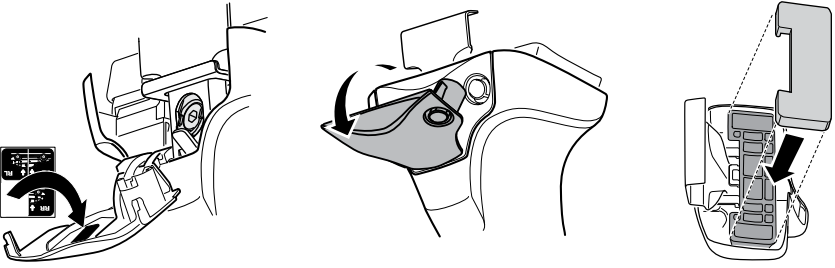

C

B

A

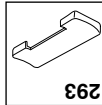
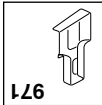

971

293

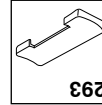
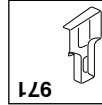

971

293

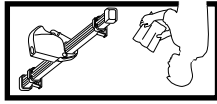
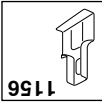

1156

KIT 1475

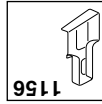
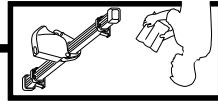
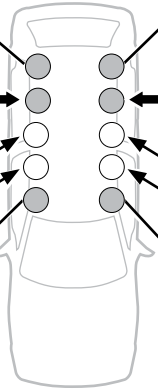

1156

KIT 1475

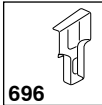

966

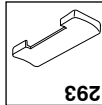

293

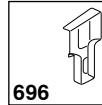

966

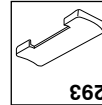

293

HYUNDAI H-1, 5-dr Van, 08-
 HYUNDAI iLoad, 5-dr Van, 08-
 HYUNDAI iMax, 5-dr Bus, 08-
 HYUNDAI Starex, 5-dr Van, 08-

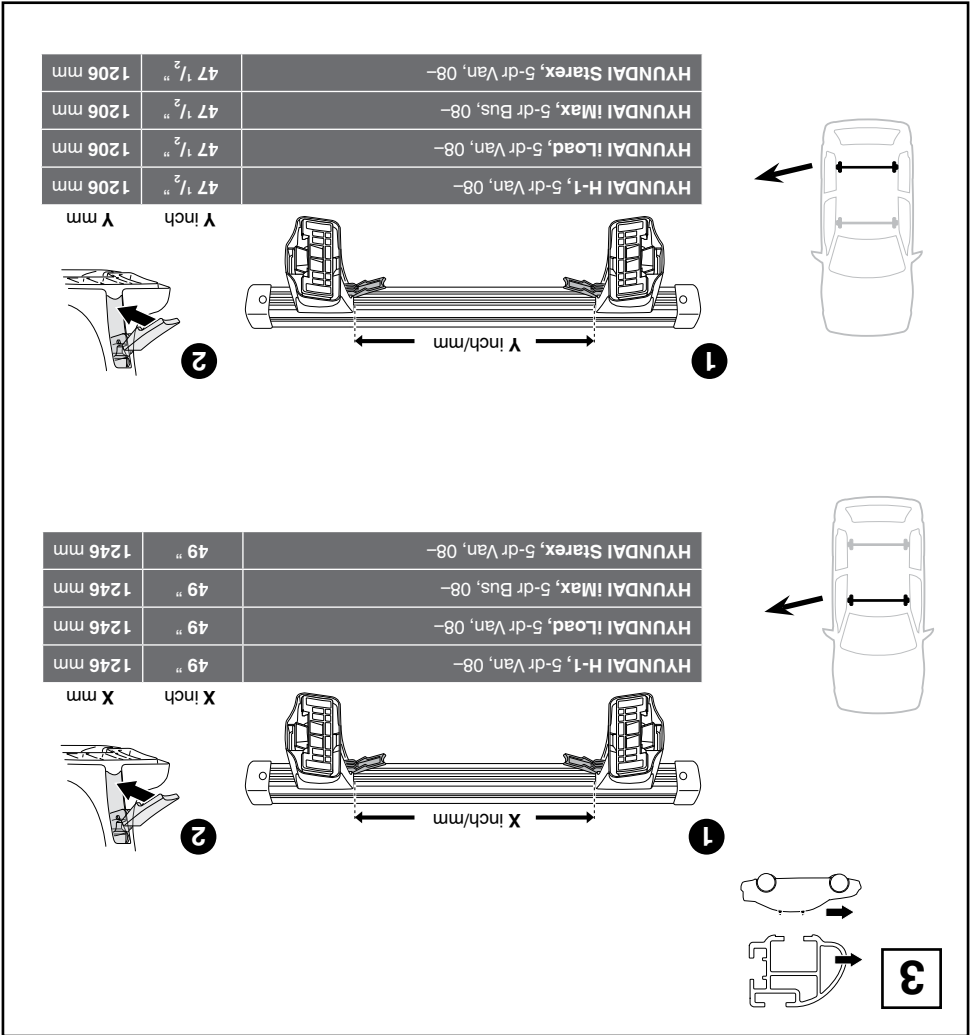
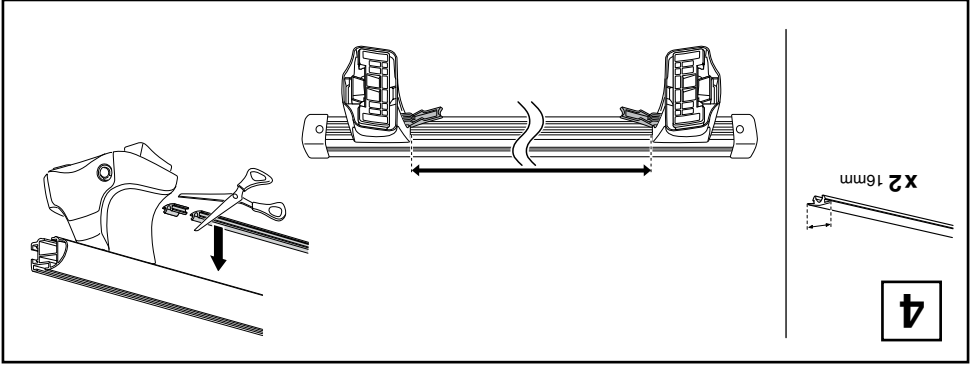

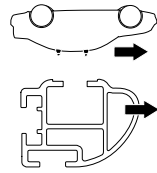
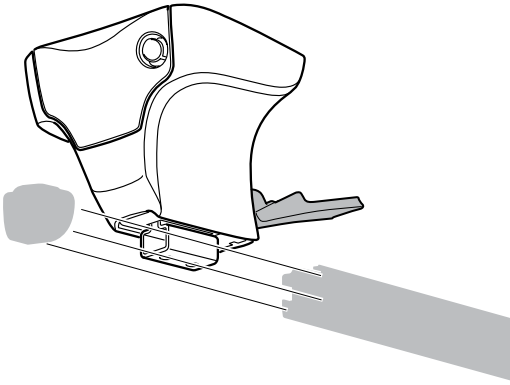
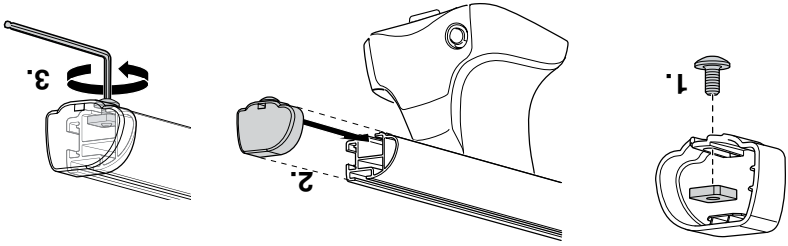

- x2
- x2
- x4
- x4
- x1 5mm

2

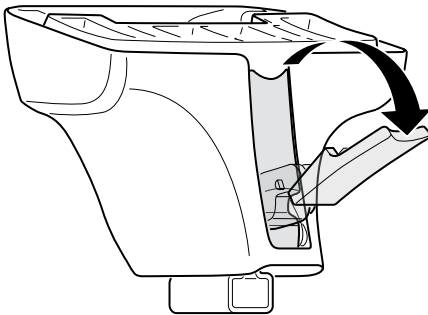

1

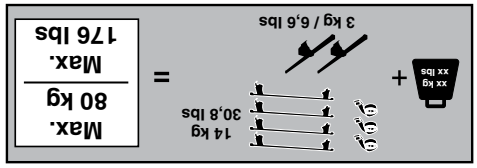
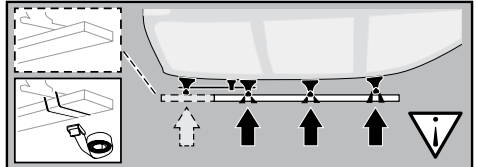
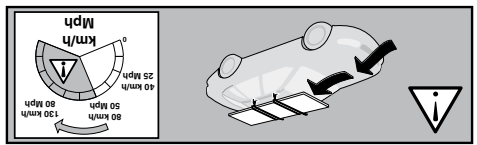
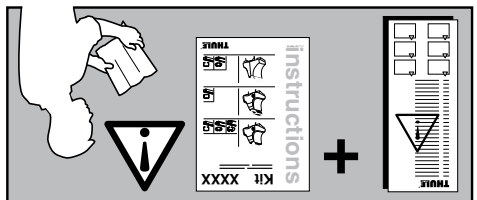
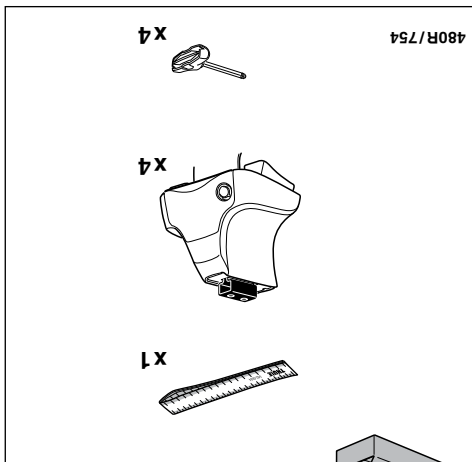
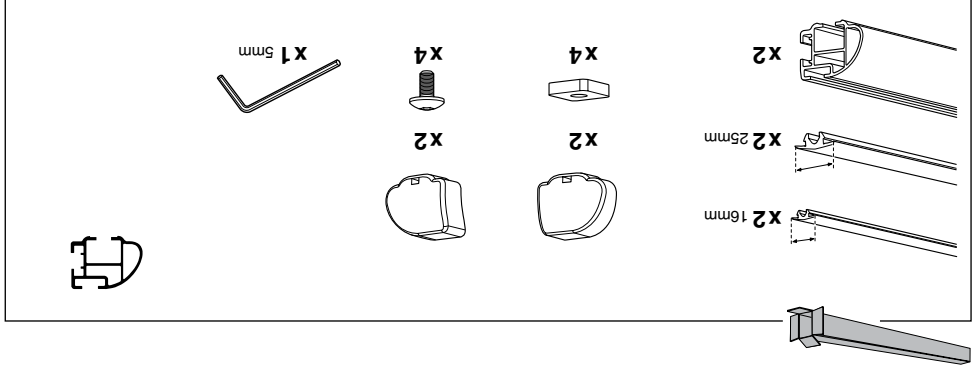
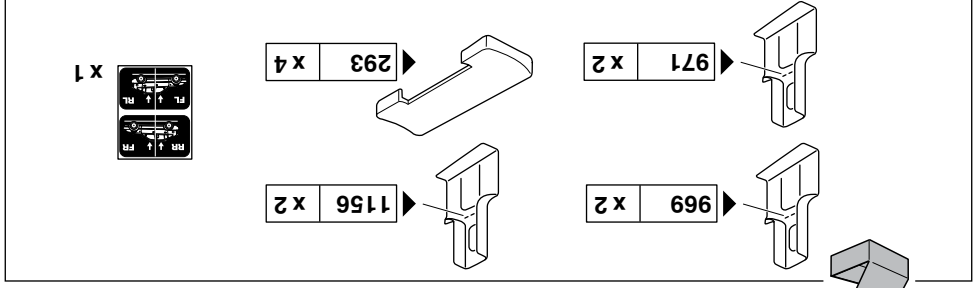

instructions

© 20110316 503-1637-01

Kit 1637

- HYUNDAI H-1, 5-dr Van, 08-*
 - HYUNDAI iLoad, 5-dr Van, 08-**
 - HYUNDAI iMax, 5-dr Bus, 08-**
 - HYUNDAI Starex, 5-dr Van, 08-*
- * with dual sliding doors
** with dual sliding doors (Asia)

480R
754

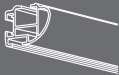
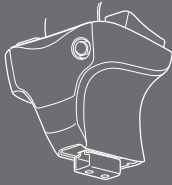

ISO 11154-E

THULE
SWEDEN

PROFESSIONAL