

Kit 1033

VOLVO S40, 4-dr Sedan, 96-99, 00-01, 02-03 / *00-04

VOLVO V40, 5-dr Estate, 96-99, 00-01, 02-03

VOLVO V40, 5-dr Wagon, *00-04

*North America

480R
754

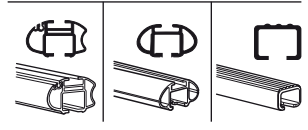
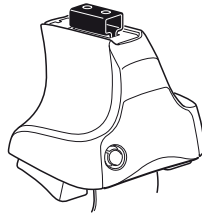

480

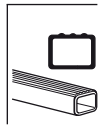
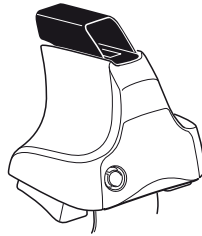

750

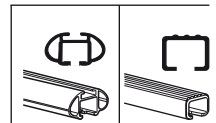
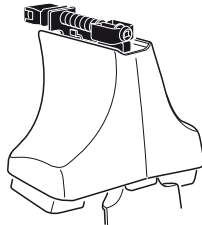

Kit



3



754

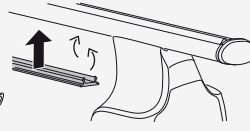
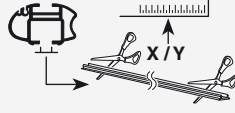

750



1

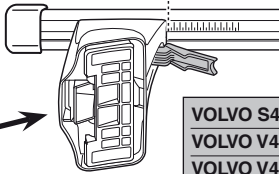
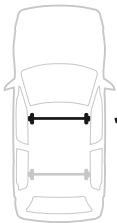

2

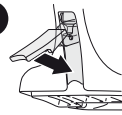

	X
VOLVO S40, 4-dr Sedan, 96-99, 00-01, 02-03 / *00-04	29
VOLVO V40, 5-dr Estate, 96-99, 00-01, 02-03	29
VOLVO V40, 5-dr Wagon, *00-04	29

1

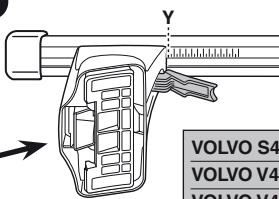
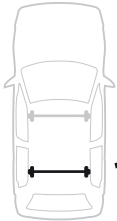

2

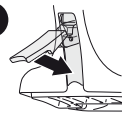

	Y
VOLVO S40, 4-dr Sedan, 96-99, 00-01, 02-03 / *00-04	25
VOLVO V40, 5-dr Estate, 96-99, 00-01, 02-03	24,5
VOLVO V40, 5-dr Wagon, *00-04	24,5



480R



480

1

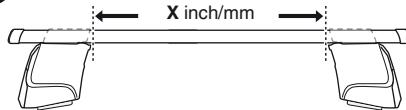

2

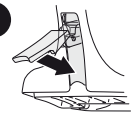

	X inch	X mm
VOLVO S40, 4-dr Sedan, 96-99, 00-01, 02-03 / *00-04	37"	941 mm
VOLVO V40, 5-dr Estate, 96-99, 00-01, 02-03	37"	941 mm
VOLVO V40, 5-dr Wagon, *00-04	37"	941 mm

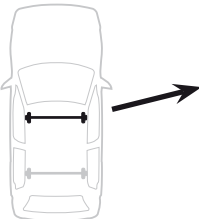

1

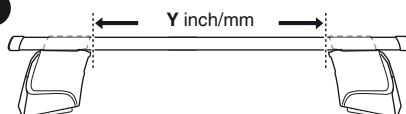

2

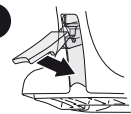

	Y inch	Y mm
VOLVO S40, 4-dr Sedan, 96-99, 00-01, 02-03 / *00-04	35 1/2"	901 mm
VOLVO V40, 5-dr Estate, 96-99, 00-01, 02-03	35 1/4"	896 mm
VOLVO V40, 5-dr Wagon, *00-04	35 1/4"	896 mm

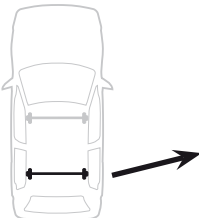

4

VOLVO S40, 4-dr Sedan, 96-99, 00-01, 02-03 / *00-04

VOLVO V40, 5-dr Estate, 96-99, 00-01, 02-03

VOLVO V40, 5-dr Wagon, *00-04

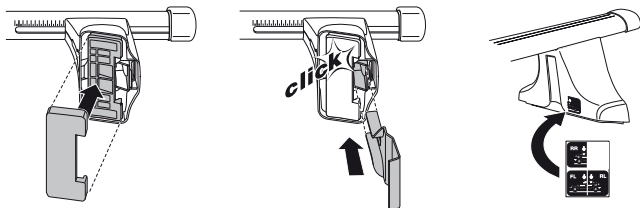
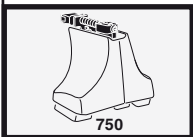
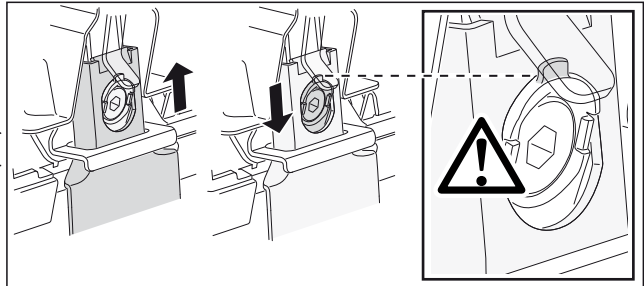
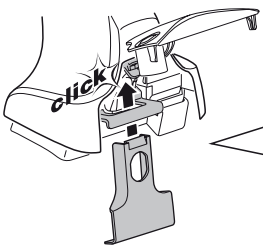
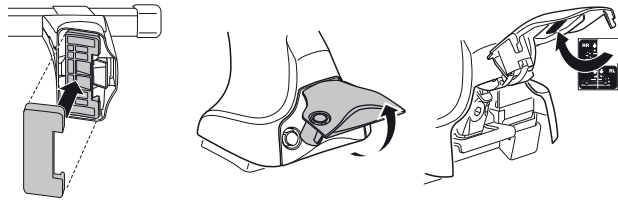
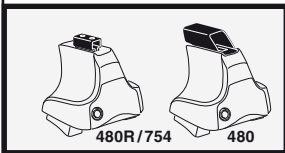
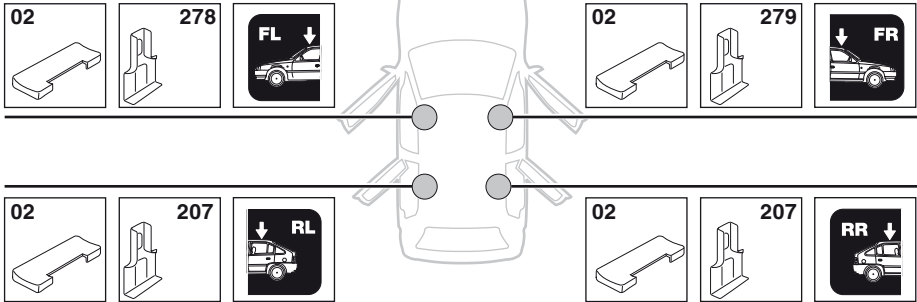

5



	X mm	Y mm	X inch	Y inch
VOLVO S40 , 4-dr Sedan, 96-99, 00-01, 02-03 / *00-04	210 mm	650 mm	8 1/4"	25 5/8"
VOLVO V40 , 5-dr Estate, 96-99, 00-01, 02-03	210 mm	700 mm	8 1/4"	27 1/2"
VOLVO V40 , 5-dr Wagon, *00-04	210 mm	700 mm	8 1/4"	27 1/2"

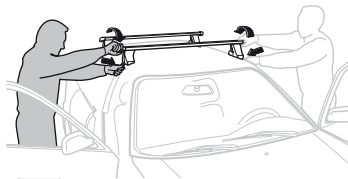
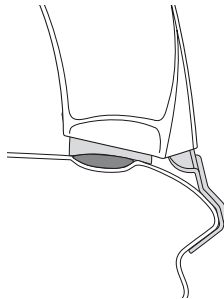
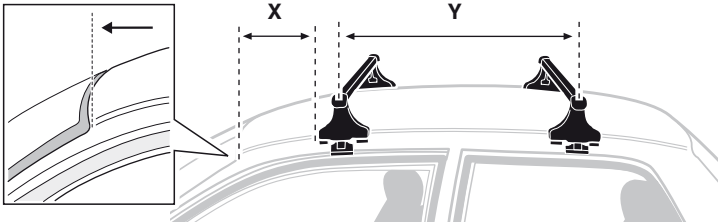

GB/US Tighten alternately

D Die Schrauben abwechselnd anziehen

F Serrer alternativement chaque côté

NL Afwisselend aan de linker- en de rechterkant aandraaien

I Alternare il serraggio delle viti

E Serrare alternativamente

PT Aperte alternadamente

S Dra åt växelvis

FIN Kierrä vuorotellen

EST Pinguldage vaheldumisi

LAT Pielieciet pamišus

LIT Užsukinkite pakaitomis

PL Śruby dokręcaj naprzemiennie

RU Затягивайте попеременно

CZ Pokręťte bagážníka dokręcaj dokręcaj naprzemiennie.

SK Doťahujte striedavo

SLO Privijajte izmenično.

HR Naizmjenično zategnite

HU Egymástól függetlenül szorítandó

GR Σφίγγετε εναλλάξ

TR Dönüşümlü sıkın

中文 交替拧紧

한국어 번갈아 가며 조이십시오.

日本語 交互に締め付けてください。

ไทย ชั้ไนแบบสลับ

6



480R/754



480



*
3 Nm



*



*
≈ 3 Nm

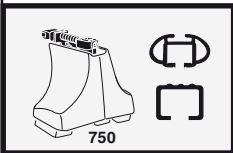
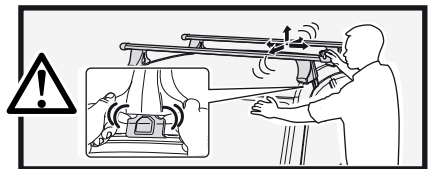

750

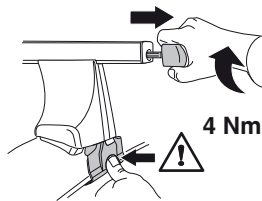

4 Nm

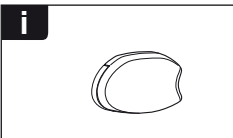
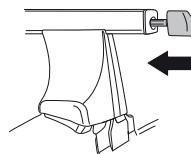

i

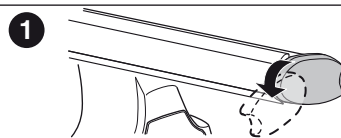

1

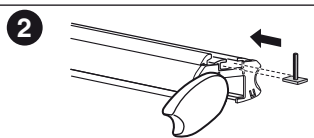

2

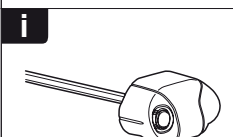

i

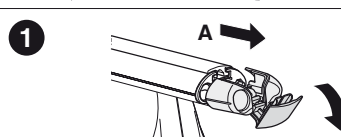

1

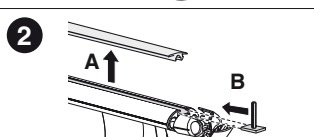

2

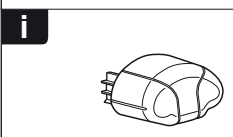

i

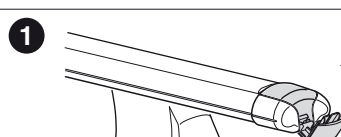

1

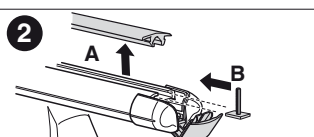

2

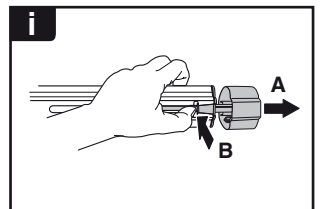
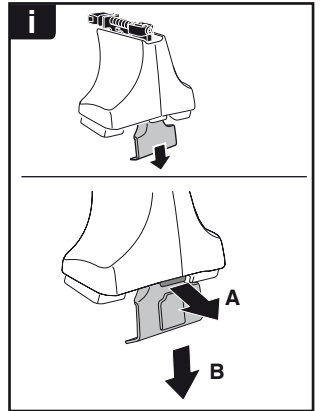

THULE
SWEDEN
**ONE
KEY
SYSTEM**



- 544 (x4)
- 596 (x6)
- 588 (x8)
- NA 510 (x10)
- EUR 452 (x12)
- ASIA



WW ▶ Thule Sweden AB, Box 69, 330 33 Hillerstorp, SWEDEN
NA ▶ Thule Inc., 42 Silvermine Road, Seymour, Connecticut 06483, USA

info@thule.com
customer.service@thule.com

www.thule.com